

# Poinsettia

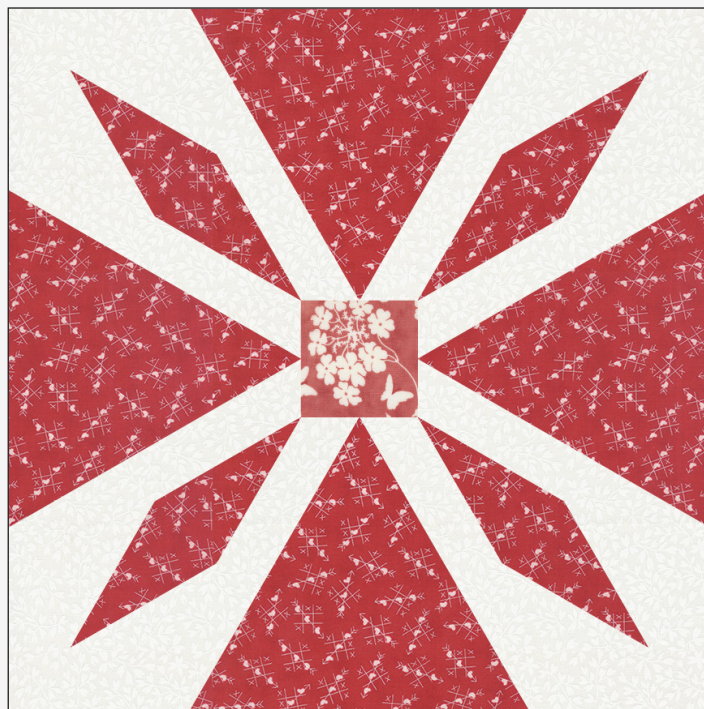

8", 9", 10" & 12" FPP Block



# Poinsettia

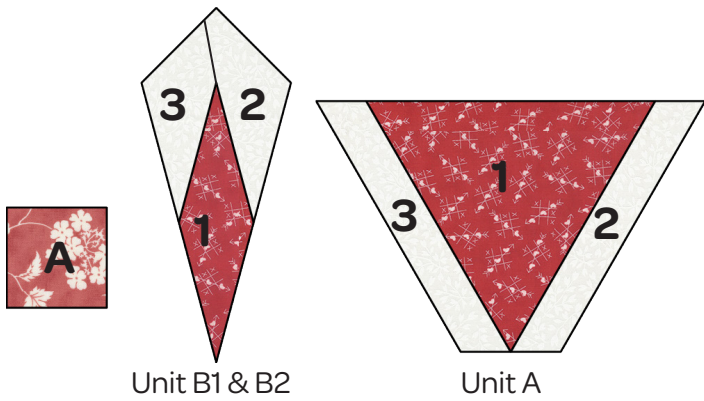

Unit B1 & B2

Unit A

## Cutting Chart:

Unit A					
Sec	Qty	Size 8"	Size 9"	Size 10"	Size 12"
1	4	5"x6"	5"x6"	5½"x6½"	6 ½" x 7"
2, 3	8	1½"x6¼"	1½"x6¼"	1¾"x6½"	1¾" x 9"
Unit B1 & B2					
1	4	2"x5¼"	2"x5½"	2½"x6½"	3" x 7"
2, 3	8	2"x5"	2¼"x5¼"	2½"x6"	2 ½" x 7"
Square					
A	1	1 ⅞"	2"	2 ¼"	2 ½" sq

## Paper Piecing Instructions:

1. Print 2 copies of unit B1/B2 of the foundation patterns for the size you are making.
2. Print 4 copies of unit A.
3. Decide on your fabric colors and label each section on the pattern according to your fabric choice.
4. Cut fabric according to cutting chart and layout on your table space in the order you will sew the fabric to the foundation papers.
5. Sew the foundation papers starting with section 1. Use the glue stick to glue the wrong side of the fabric to the paper on the back side covering the seam allowance around section 1.
6. Fold back the paper using a piece of cardboard or thin plastic along the line between section 1 and 2.
7. Trim the fabric by laying the Add-A-Quarter ruler along the folded paper and trimming.
8. Lay your section 2 fabric under the section 1 fabric with right sides together along the seam allowance you trimmed in the previous step.

9. Fold the paper flat and sew on the bold line between section 1 and 2.
10. Iron the sewn section open.
11. Continue with the next section by repeating steps of folding the paper for the next section, trimming to a ¼" and then sewing on the line.
12. After the paper pattern is complete, iron flat and trim on the outside line. Remove paper.

## Block Assembly:

1. Arrange the units according to the diagram.

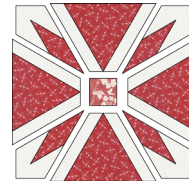

2. Starting with the top and bottom row; sew unit B2 to the left side of unit A and sew B1 to right side of unit A.

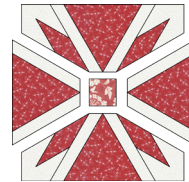

3. Sew the middle square to the remaining A units for the middle row.

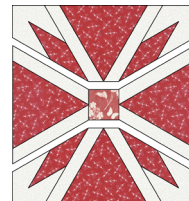

4. Start on the left side of top row, sew to middle row pivoting at intersection of square from middle row. Continue sewing to end of square, pivot at intersection, then continue up to finish sewing the row.
5. Clip the tread in the seam where it intersects the square to the seam allowance. Only on the seam next to the square. Press seam open.
6. Repeat for bottom row.
7. Block is over sized to allow for trim down. Trim block to 12 ½"

# Poinsettia

Example of 3 x 4 quilt with 2" sashing and 2" borders.

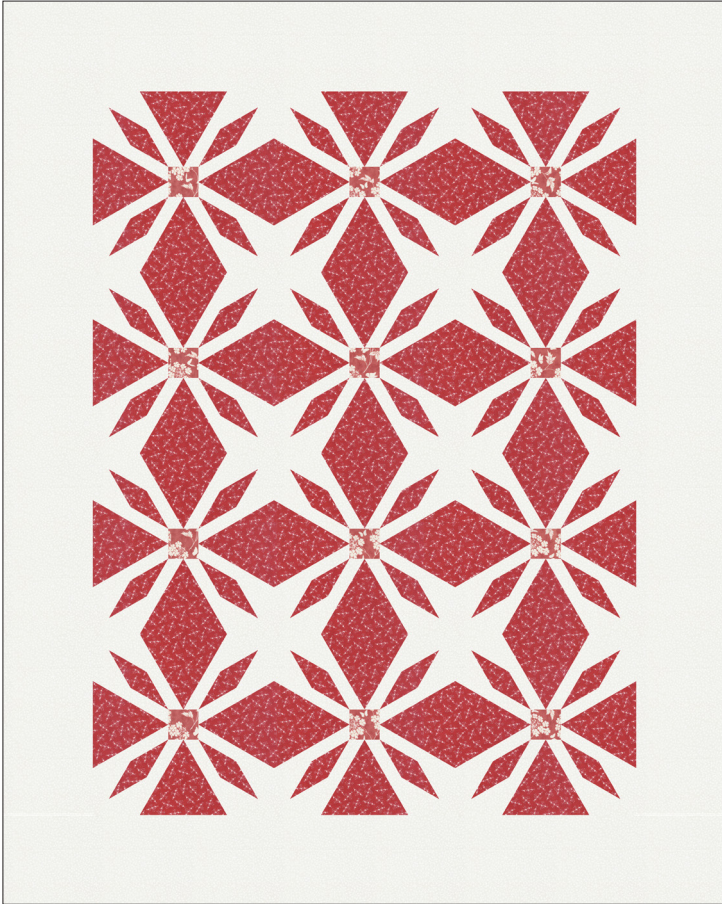

Example of 3 x 4 quilt with no sashing and 6" borders.

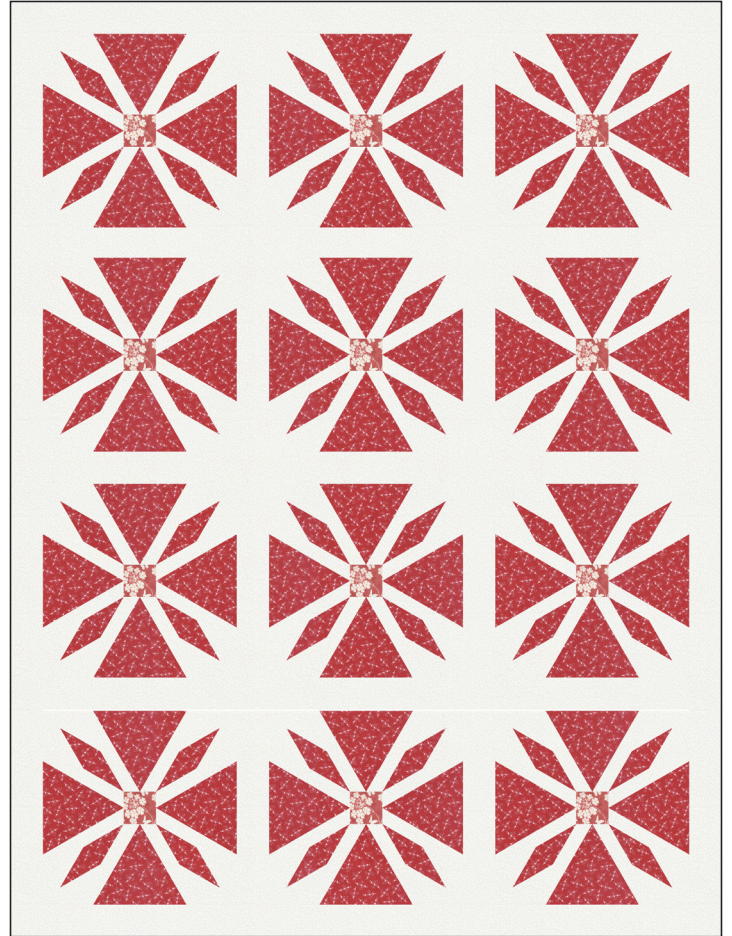

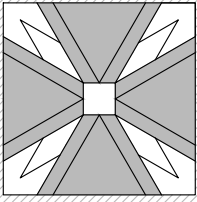
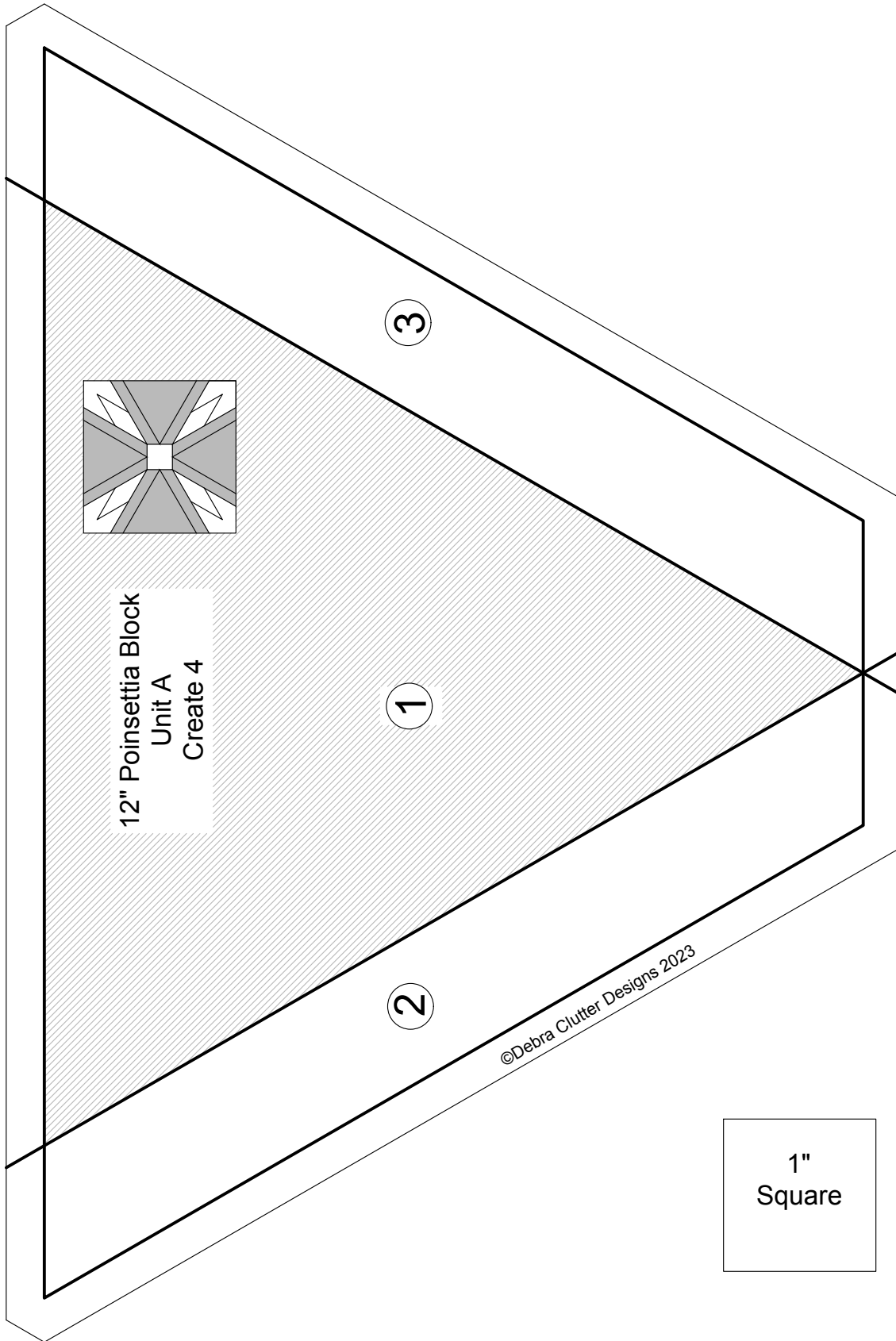

12" Poinsettia Block  
Unit A  
Create 4

3

1

2

©Debra Clutter Designs 2023

1"  
Square

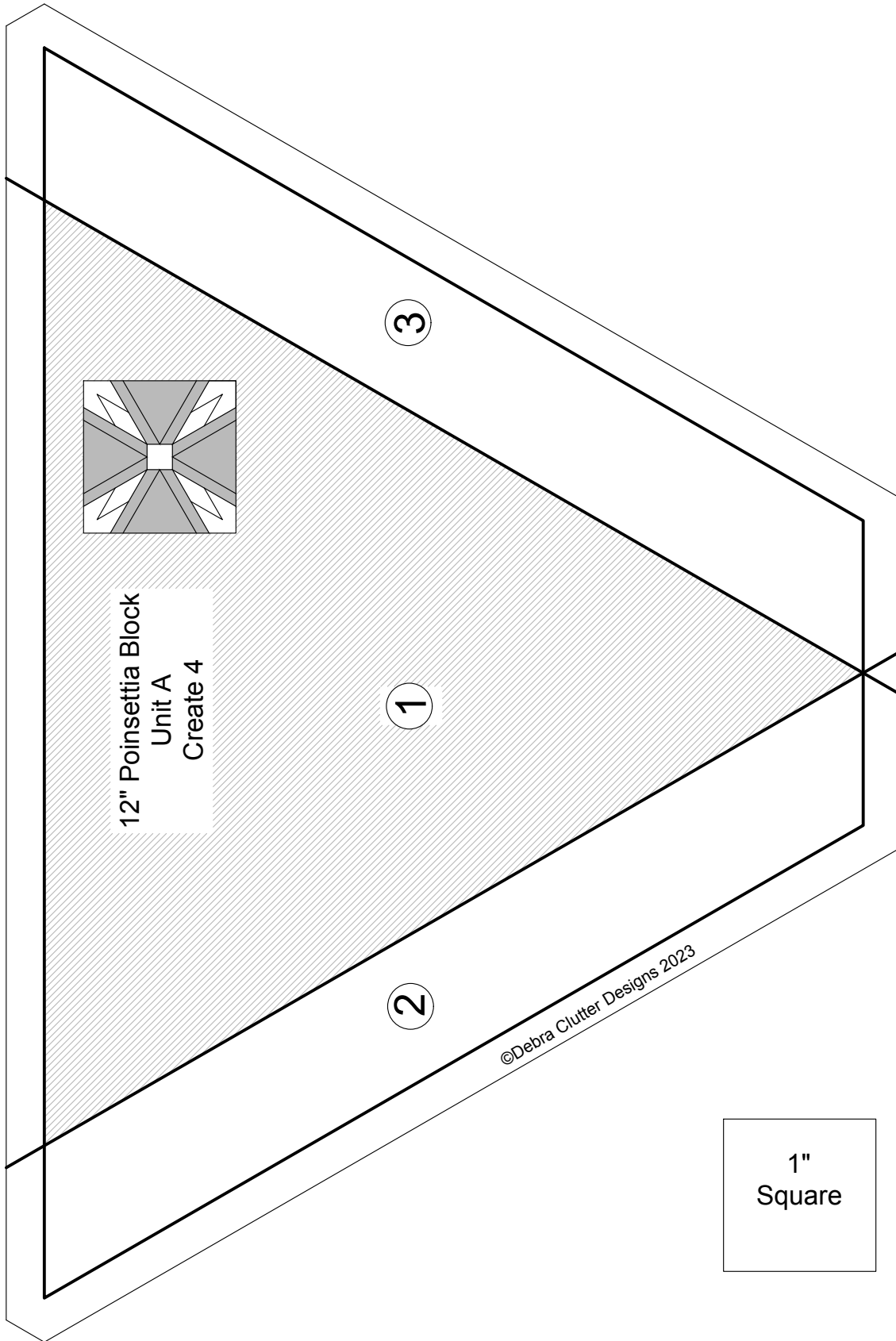

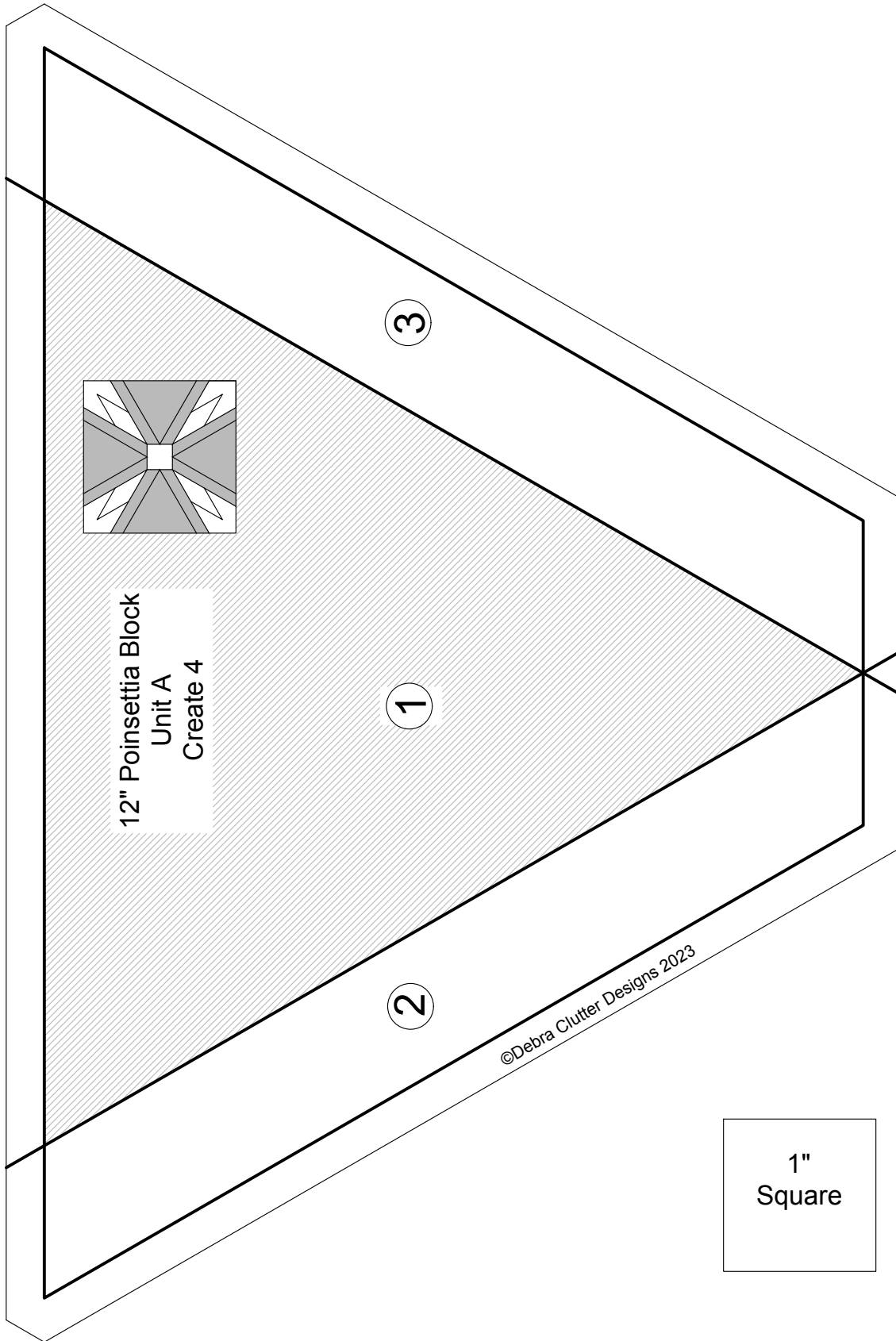

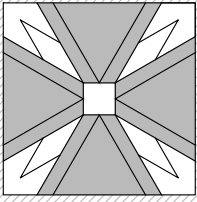
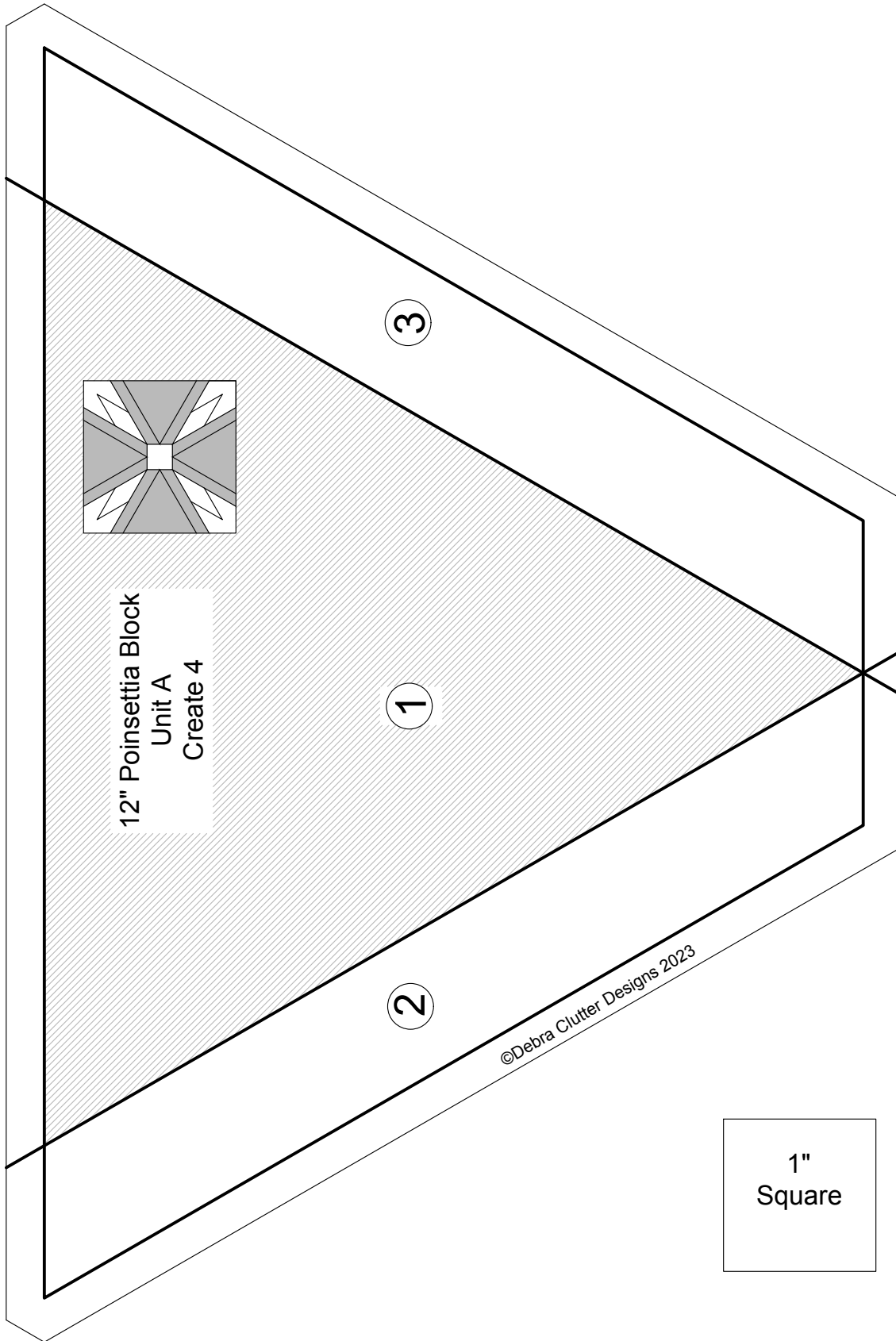

12" Poinsettia Block  
Unit A  
Create 4

3

1

2

©Debra Clutter Designs 2023

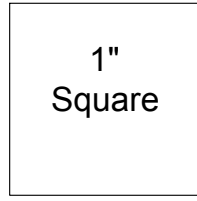

1"  
Square

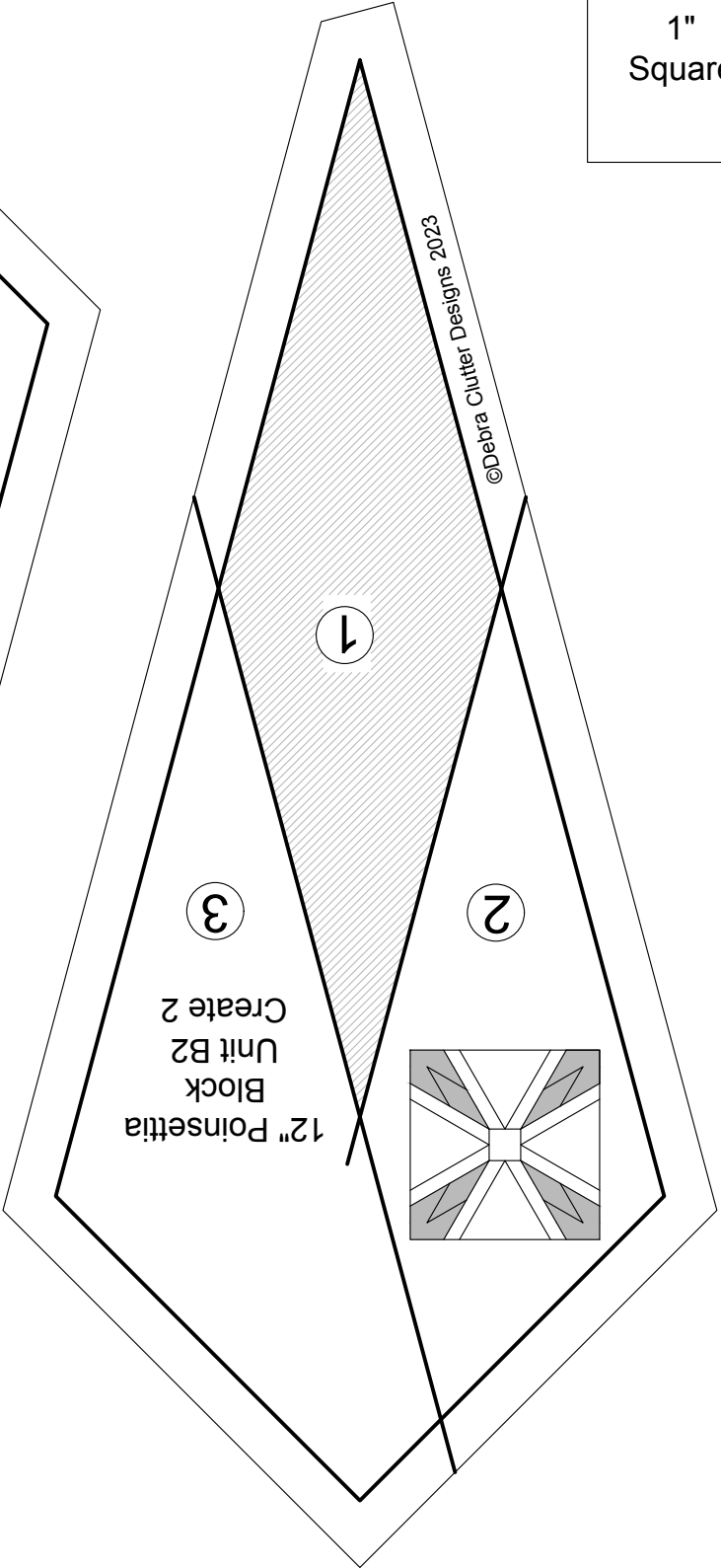
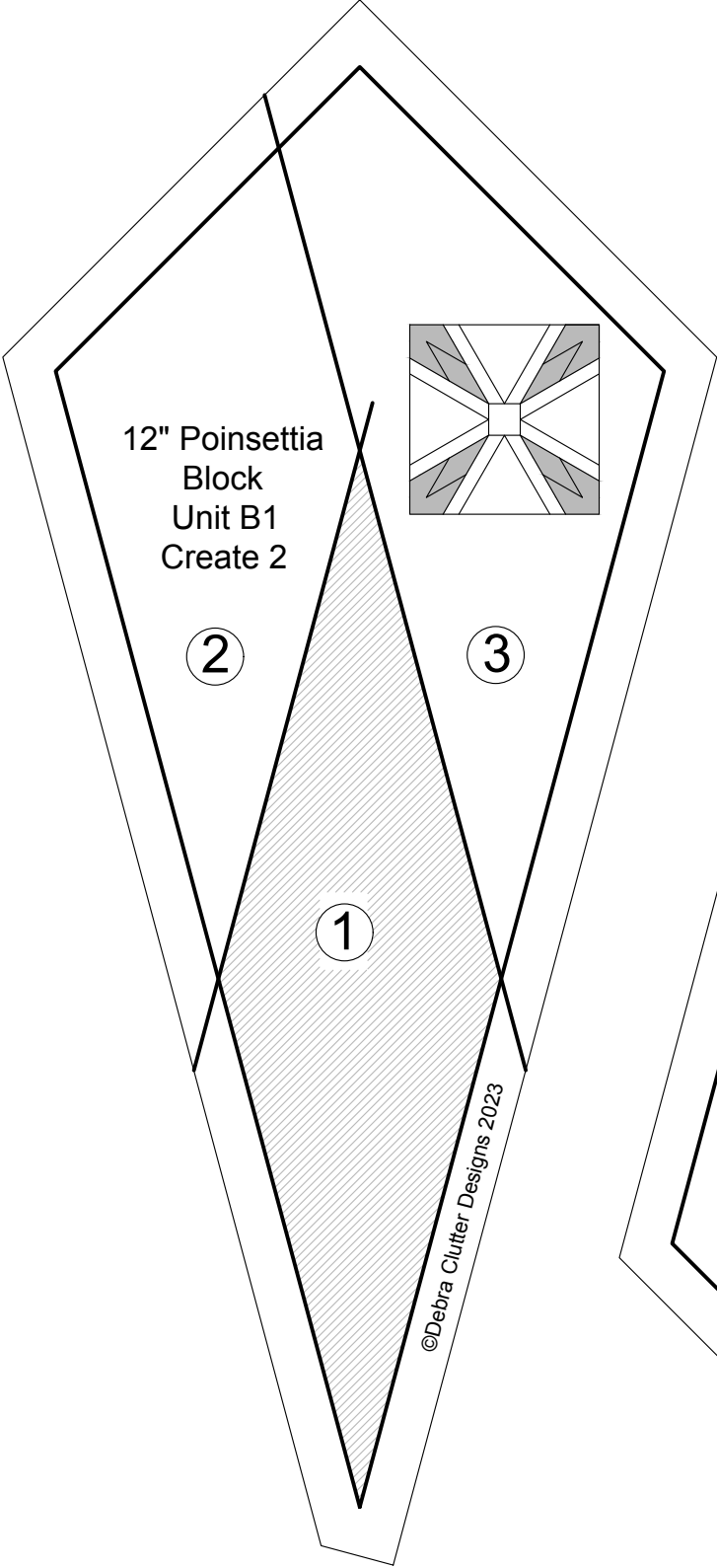



1"  
Square

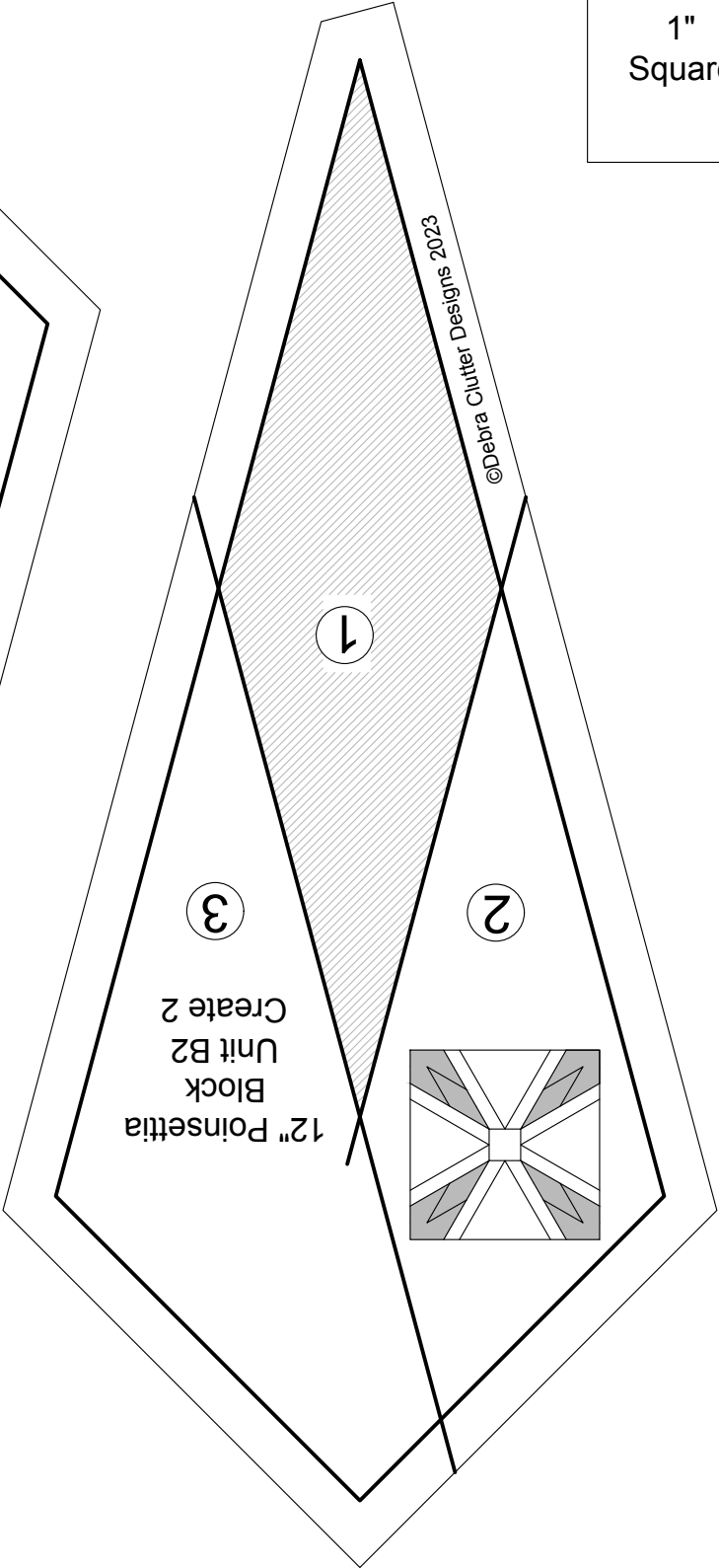
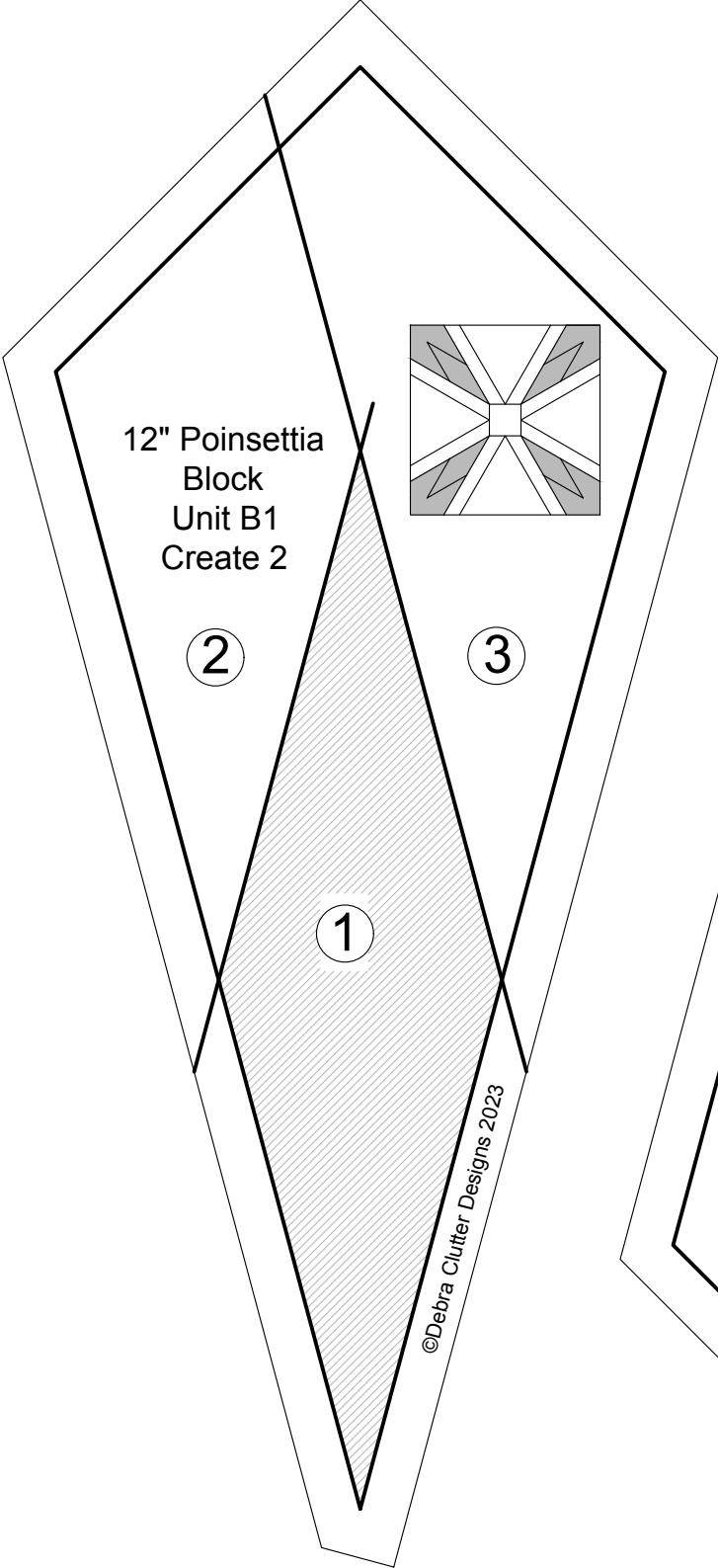

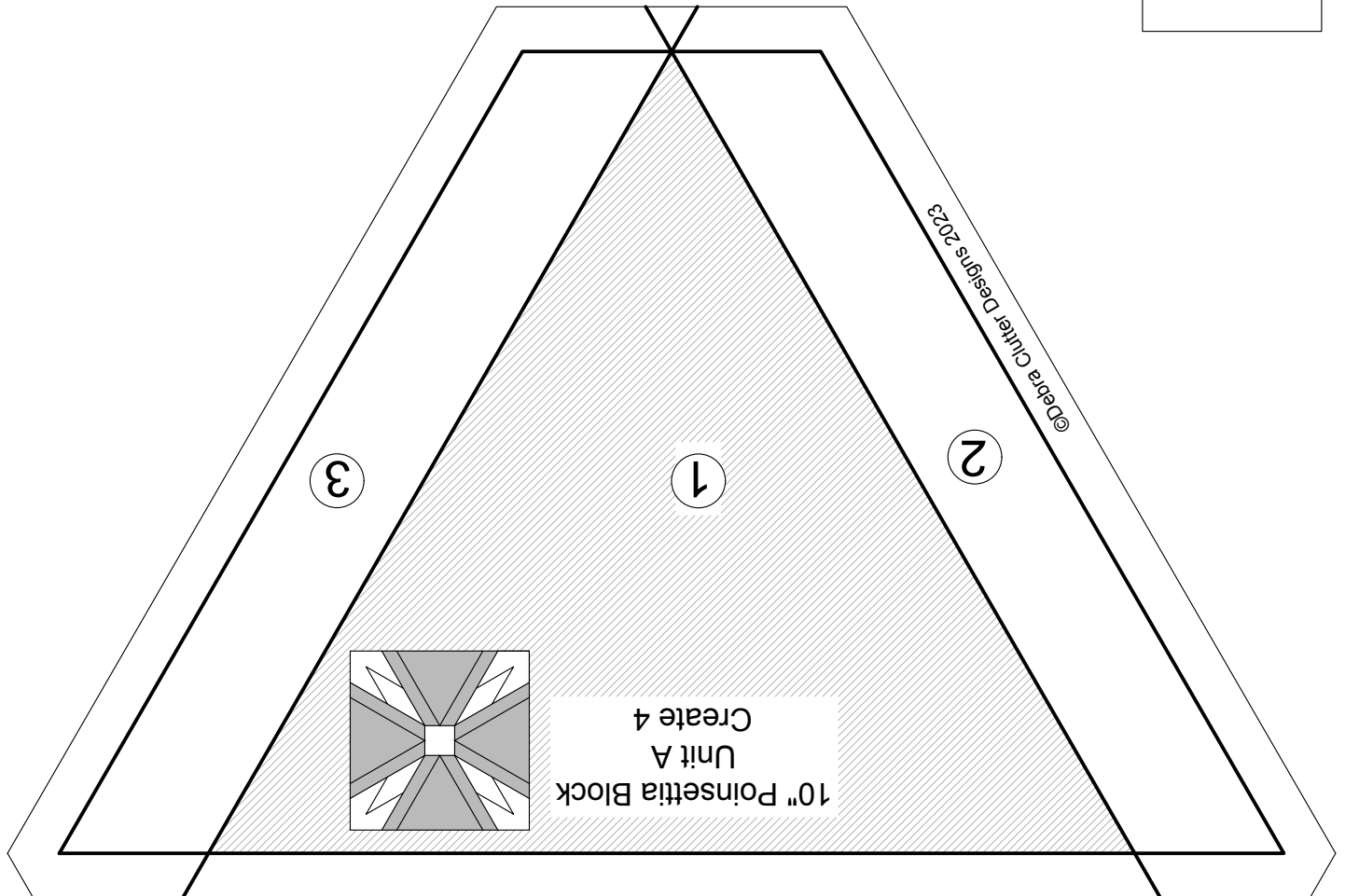
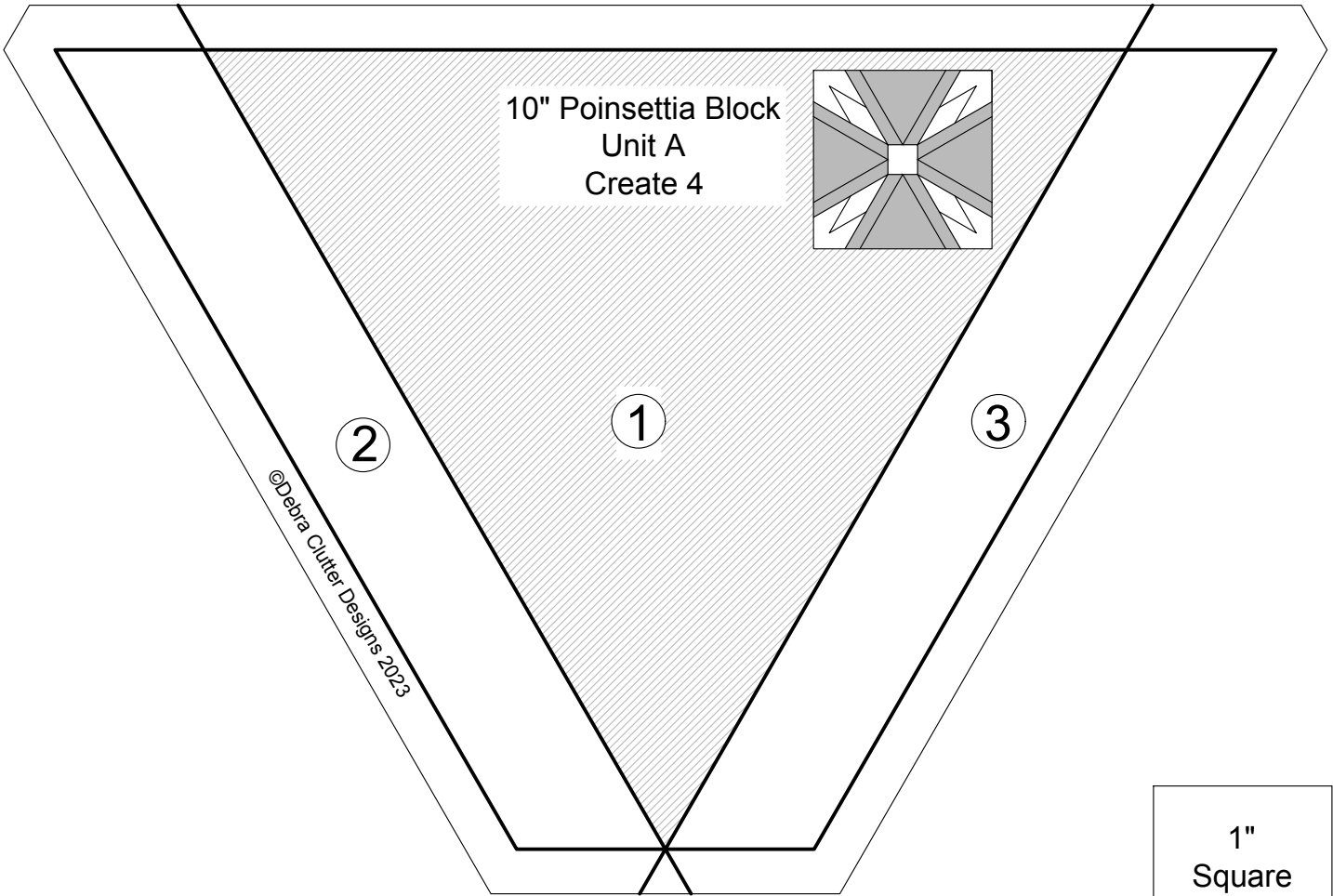

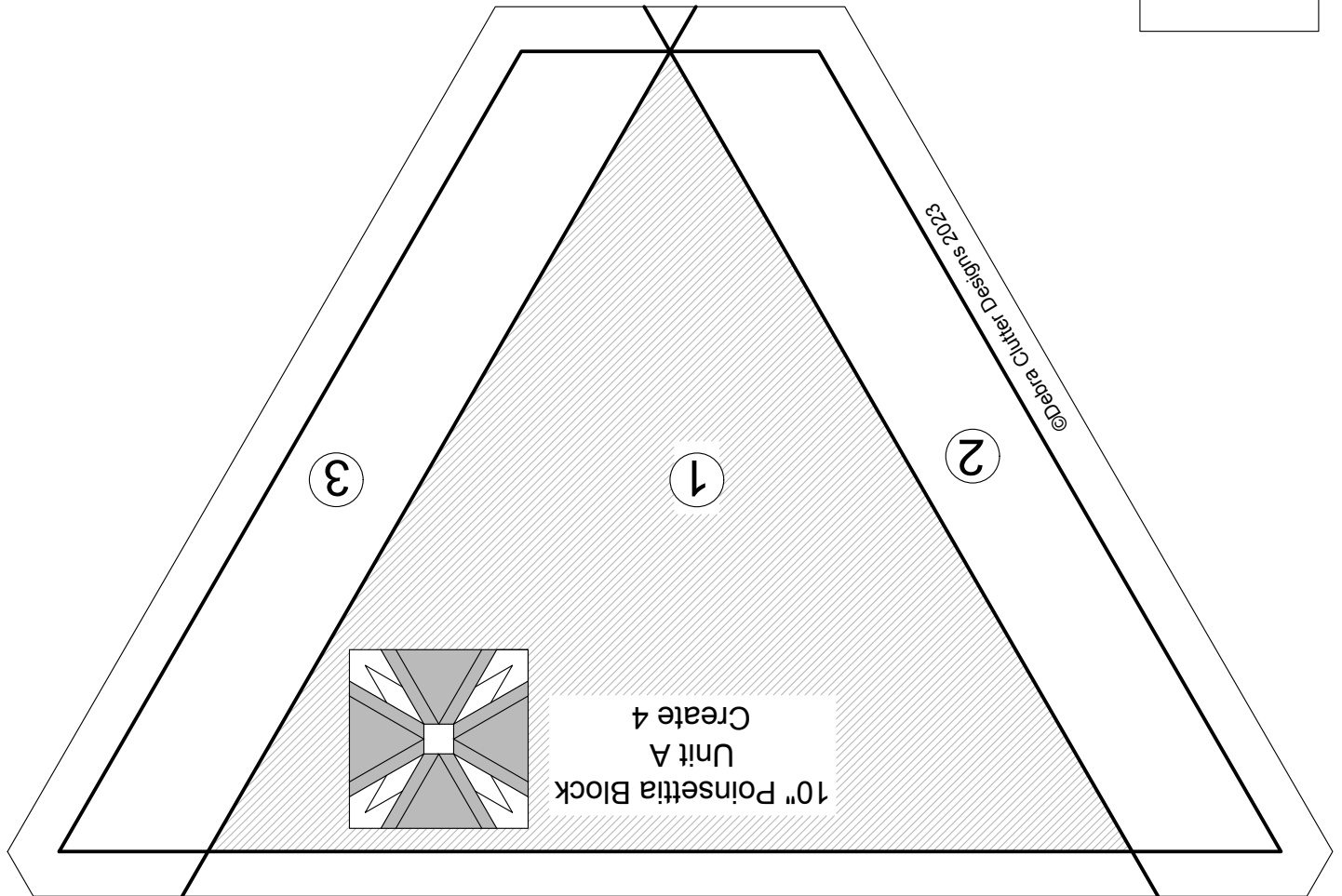
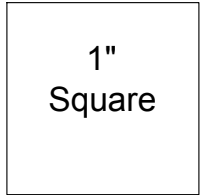
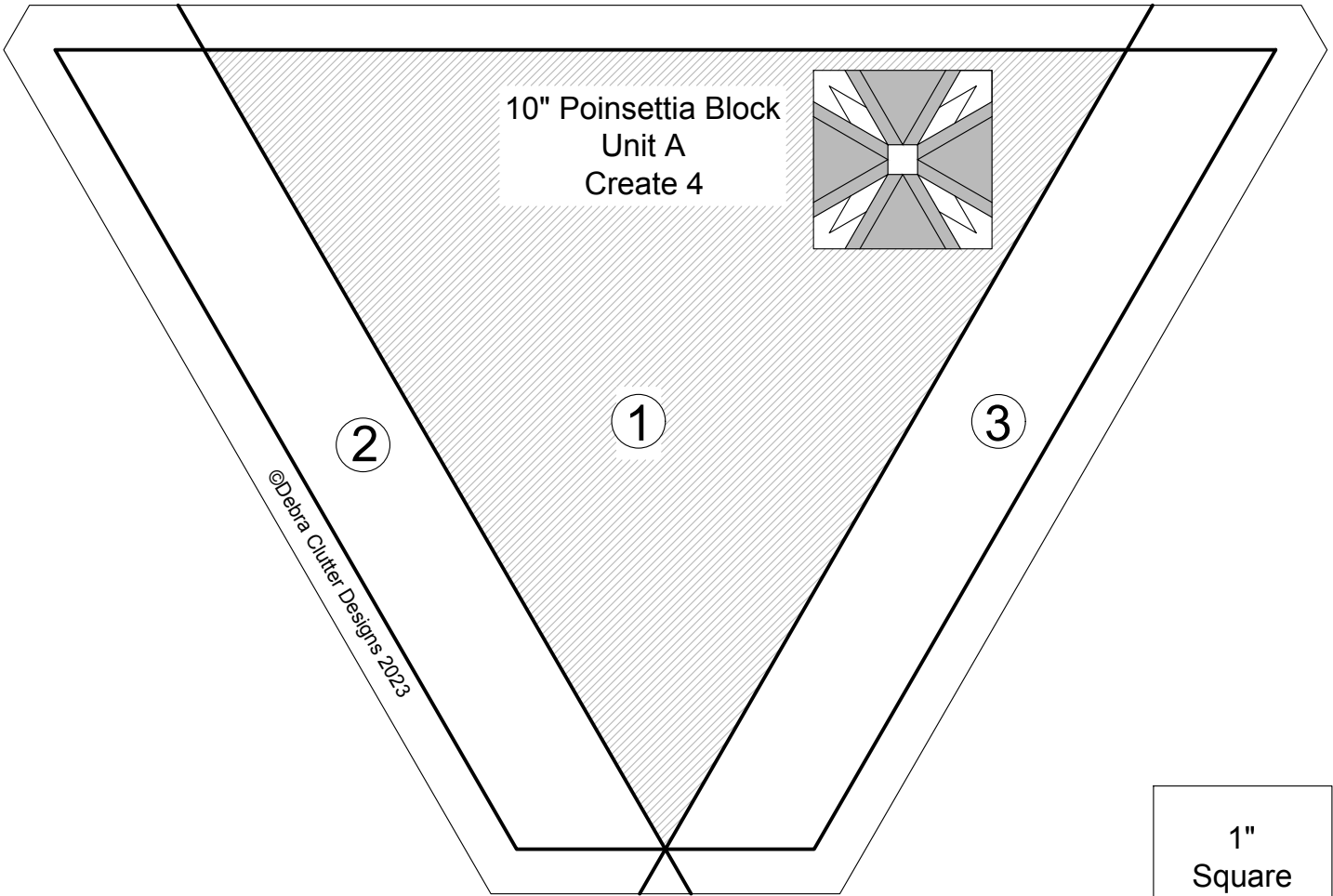

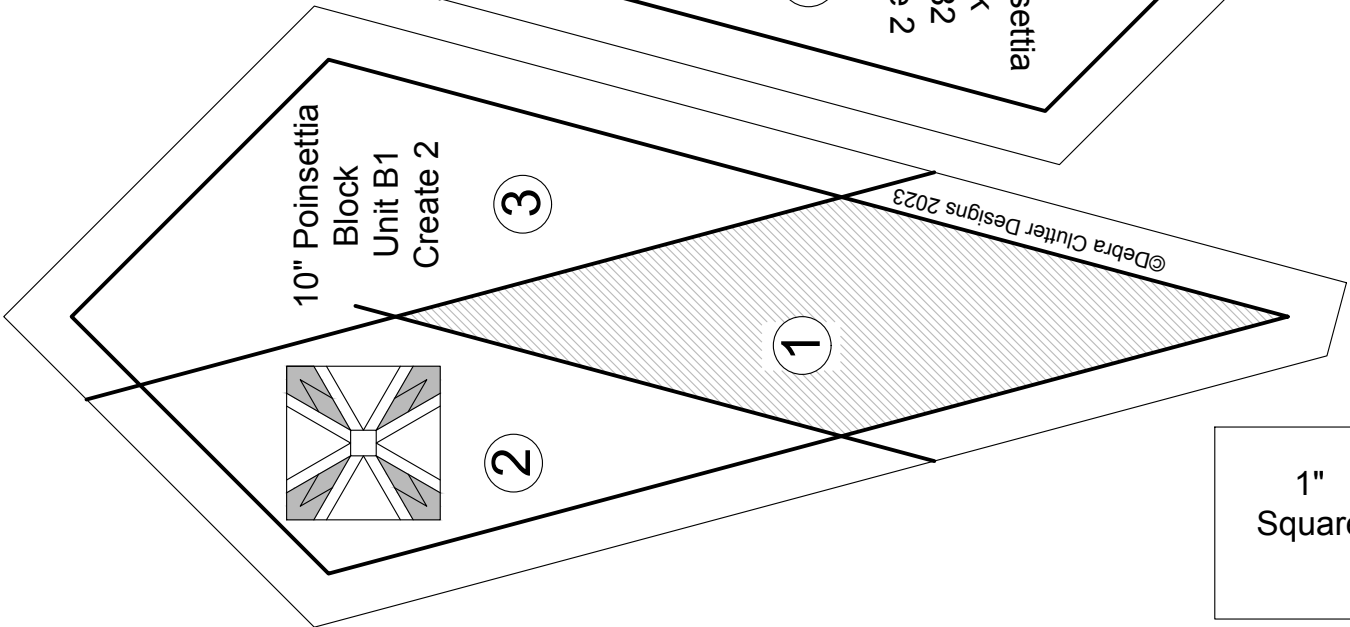
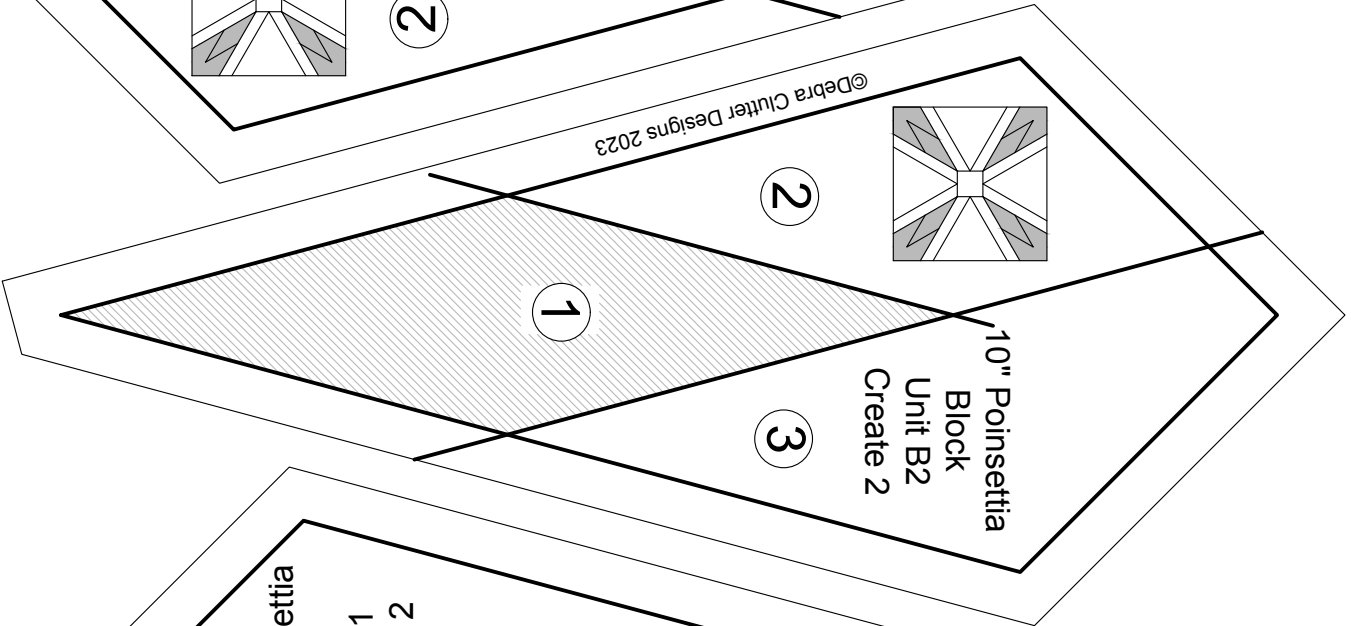
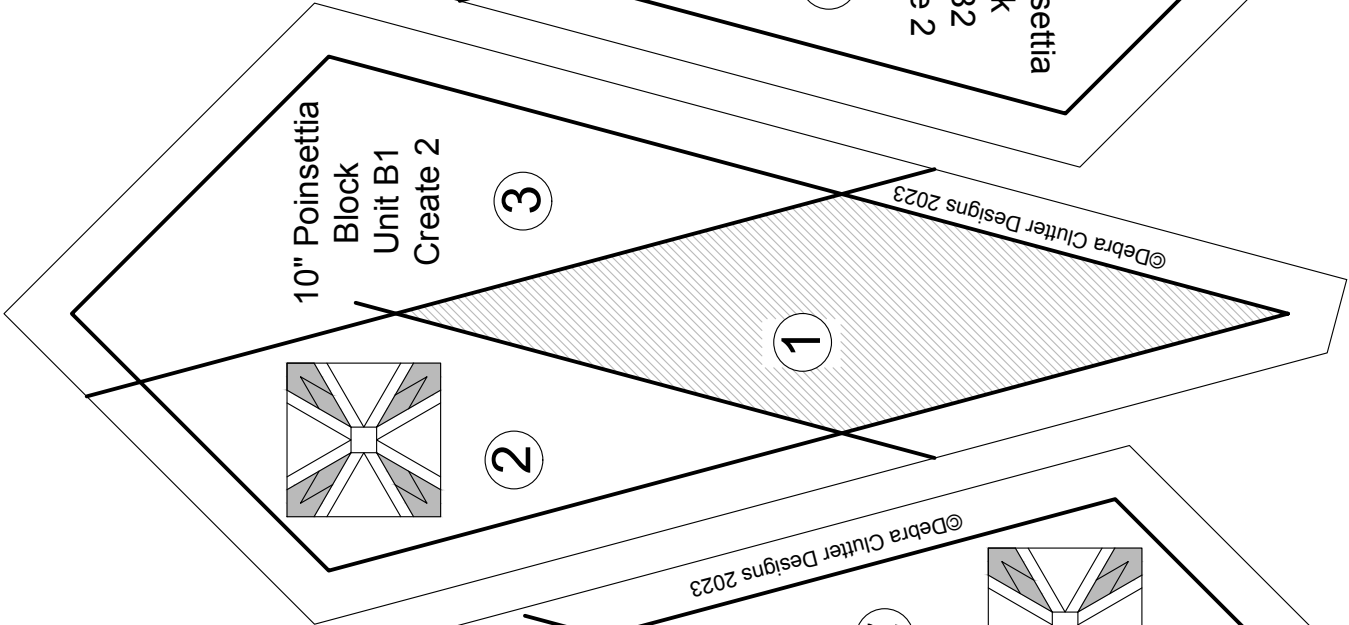
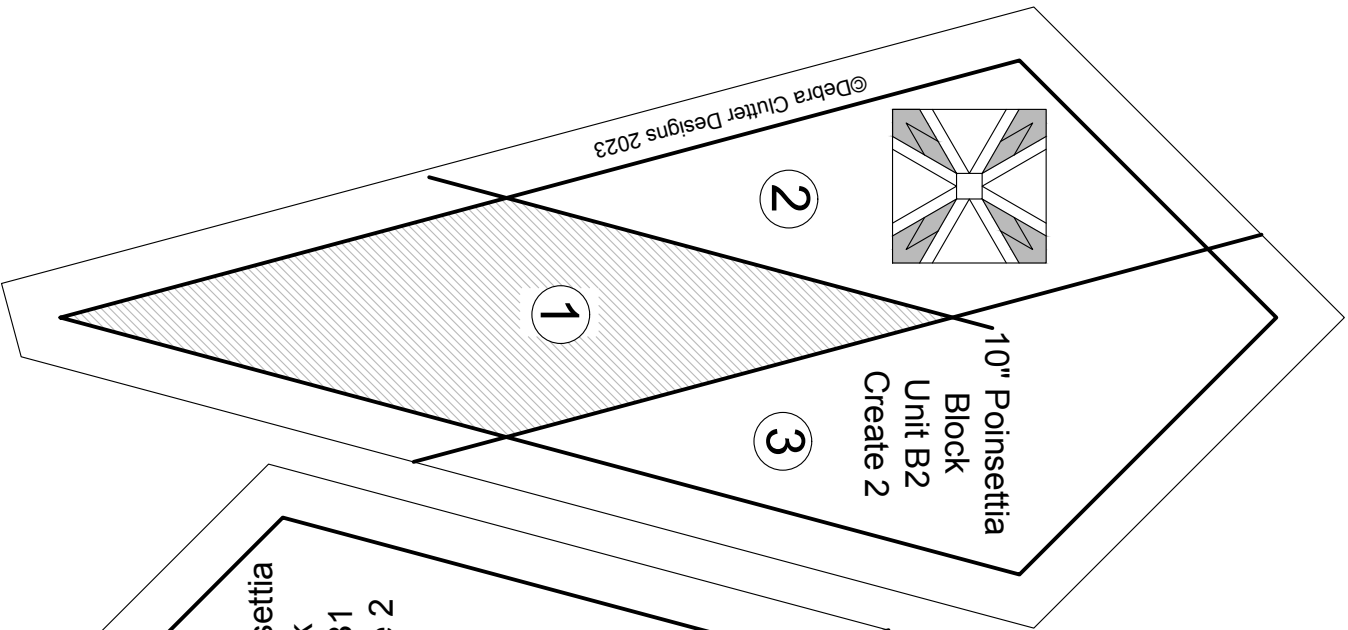
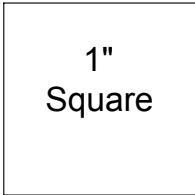

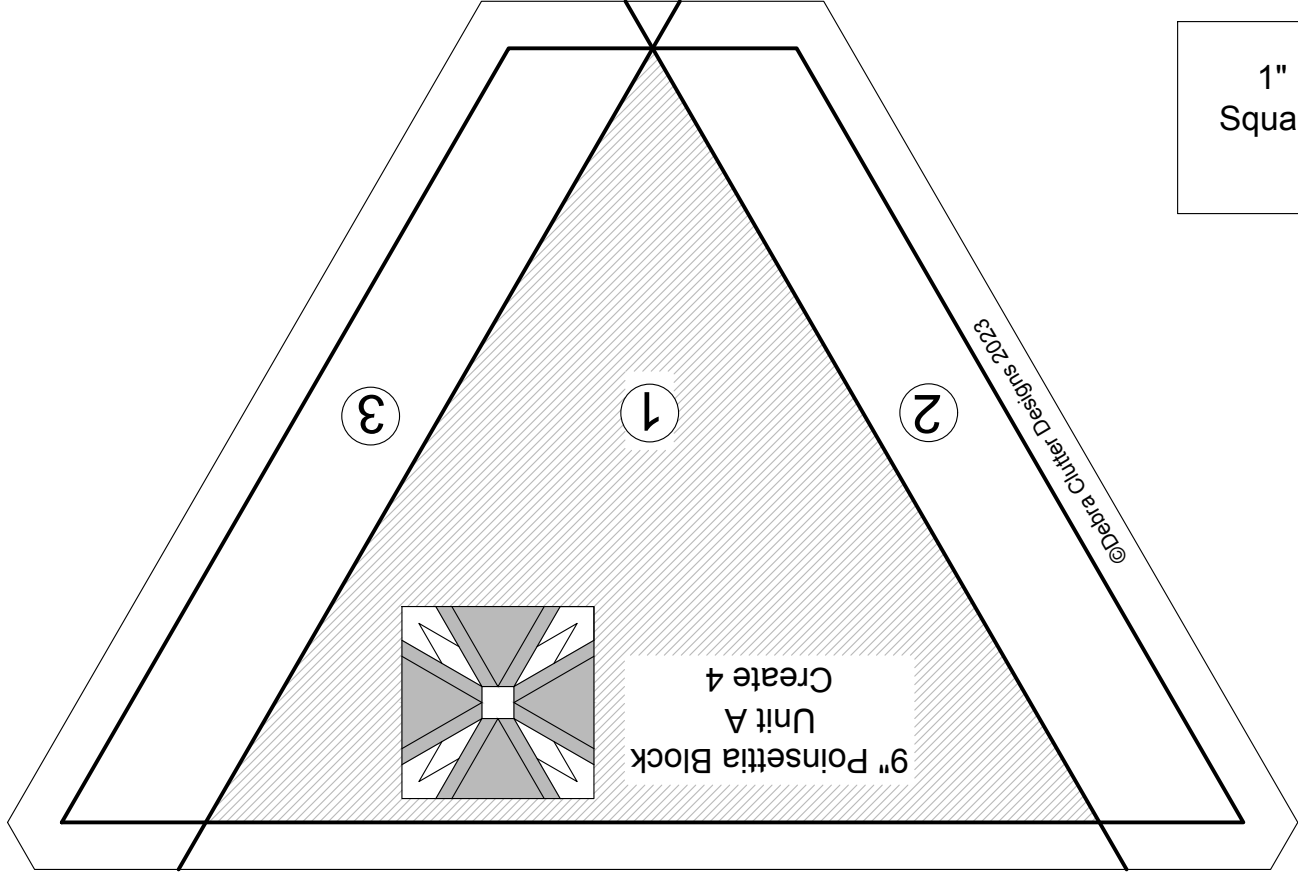
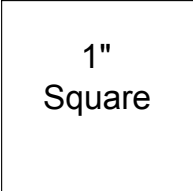
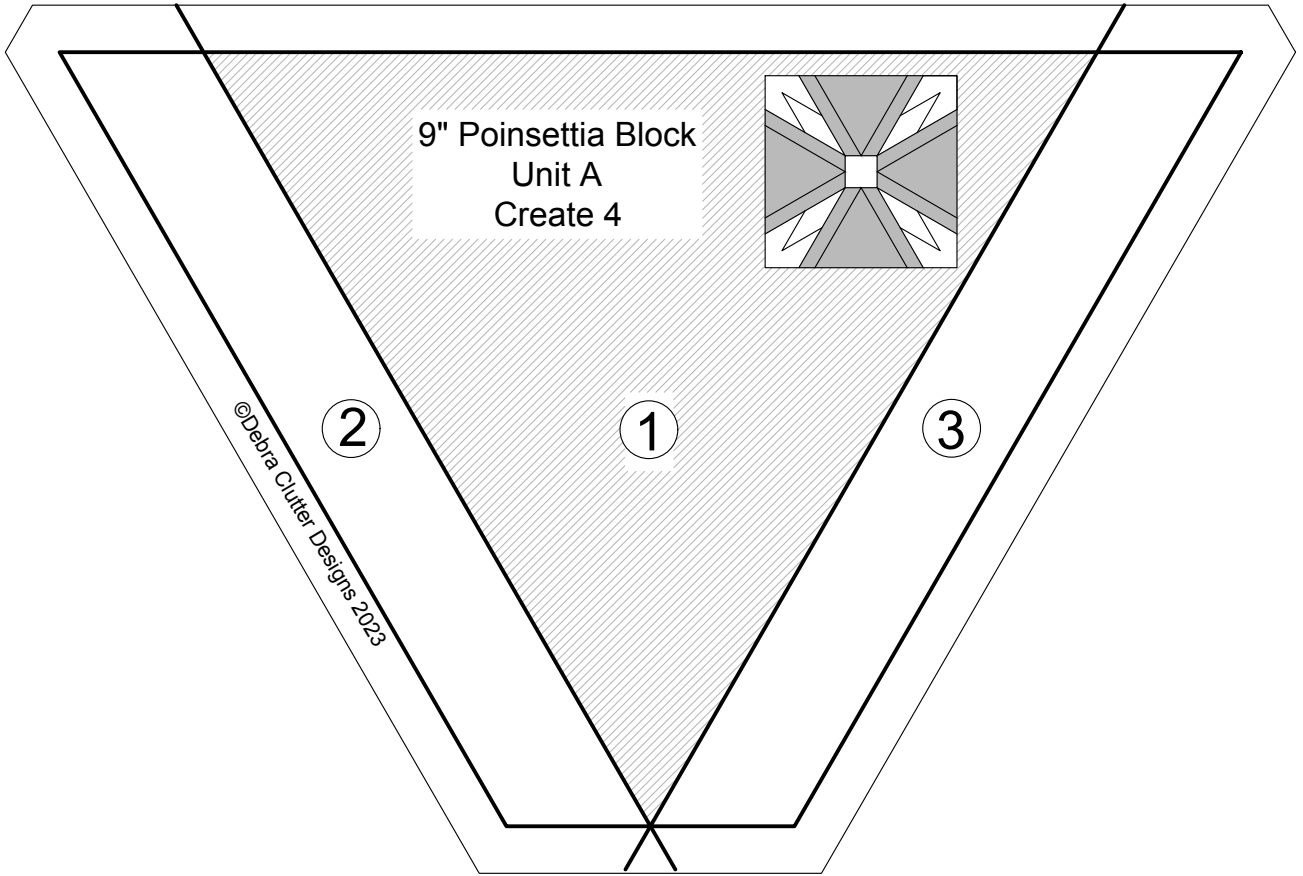

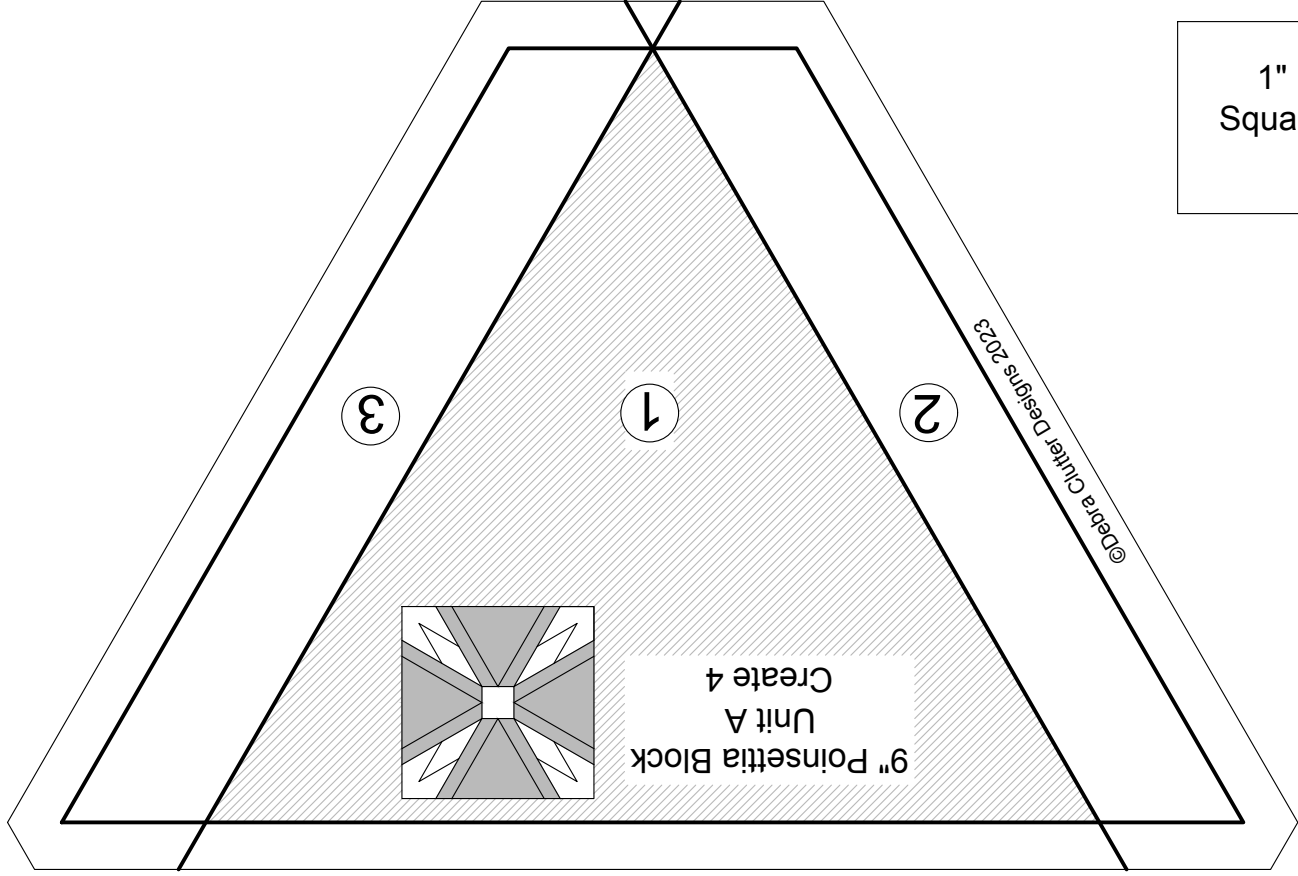
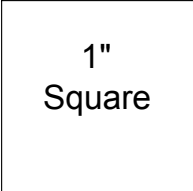
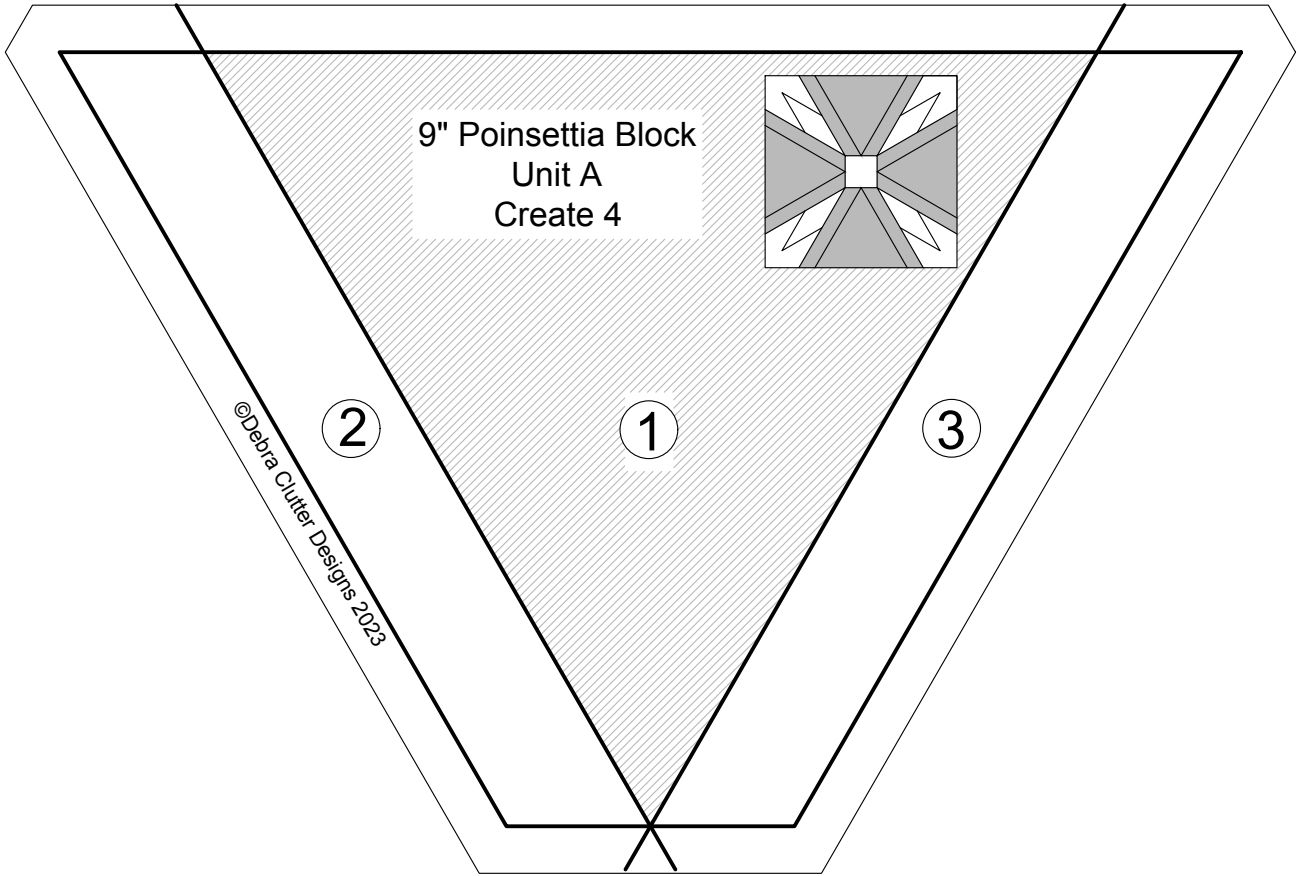

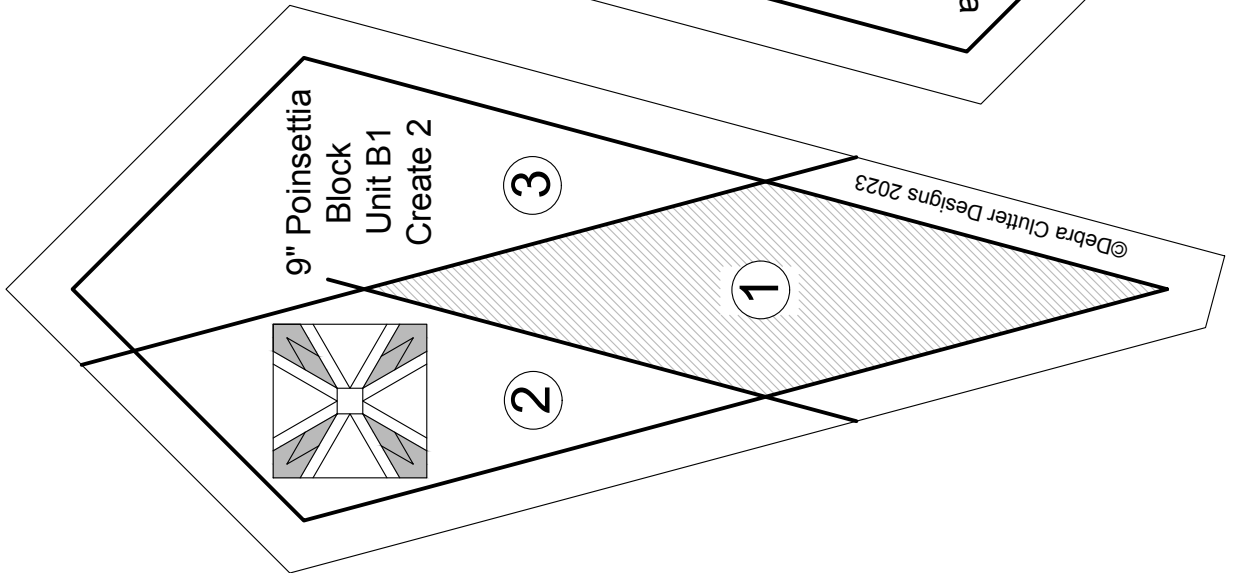
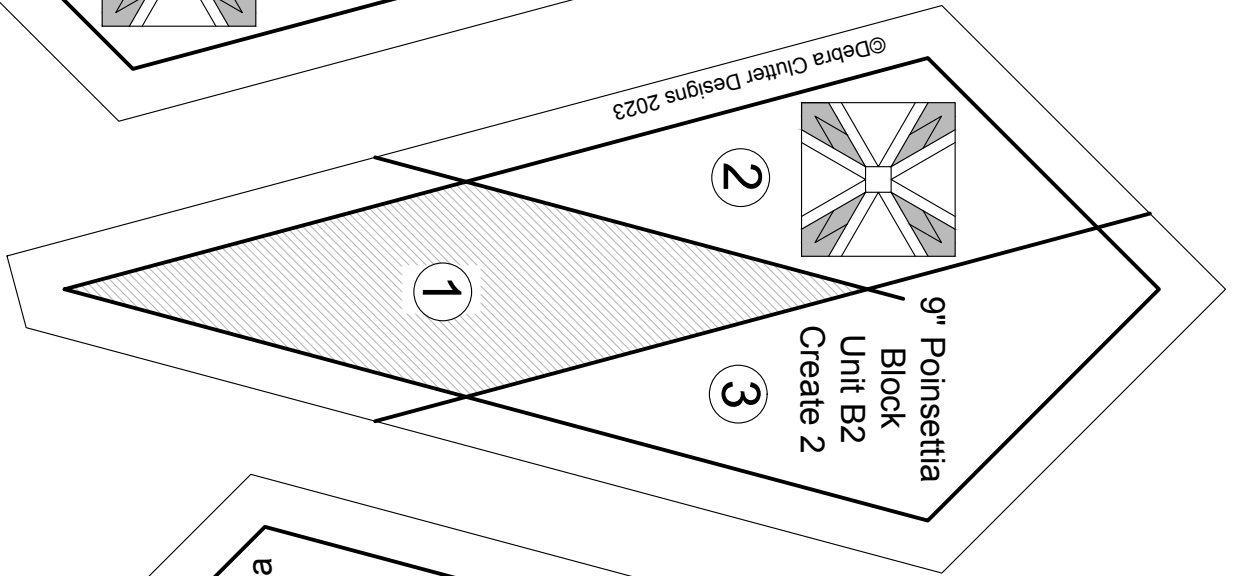
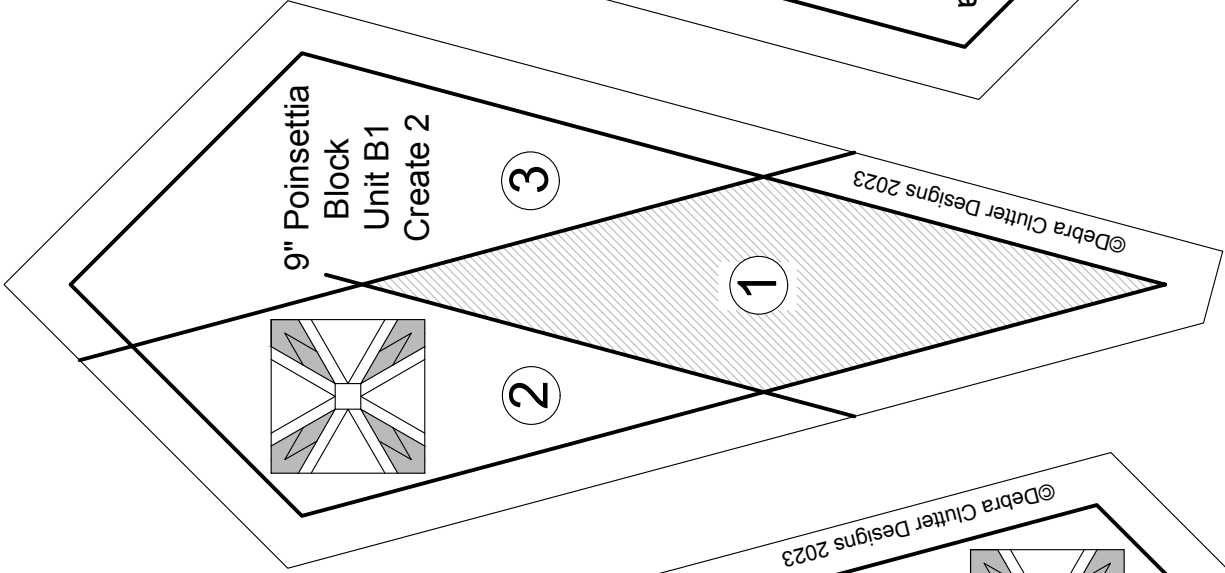
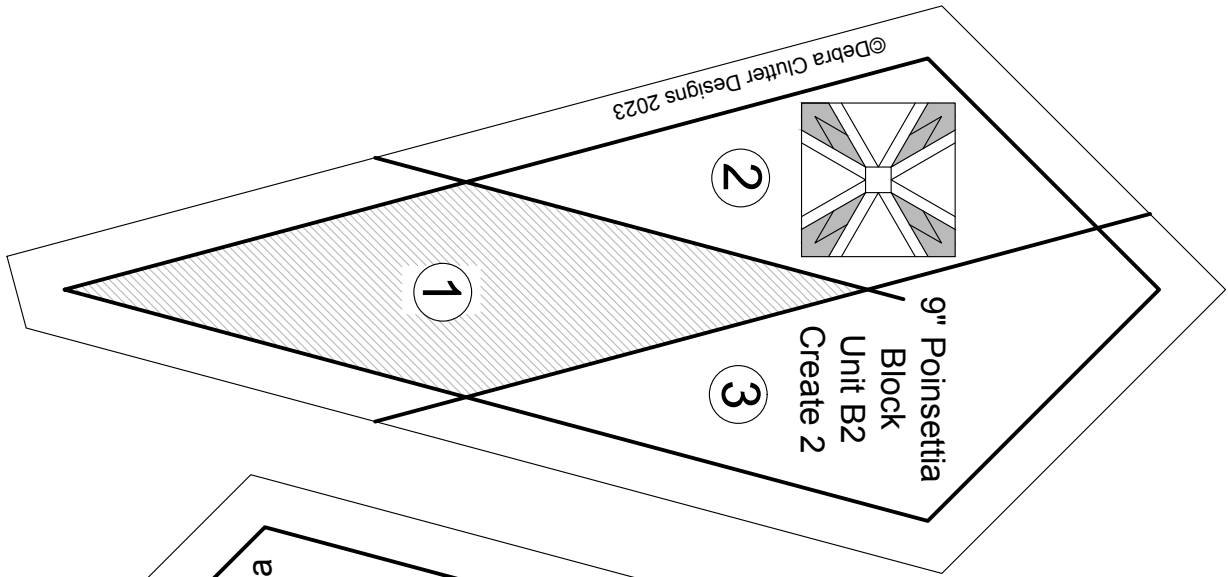
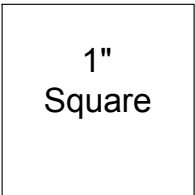

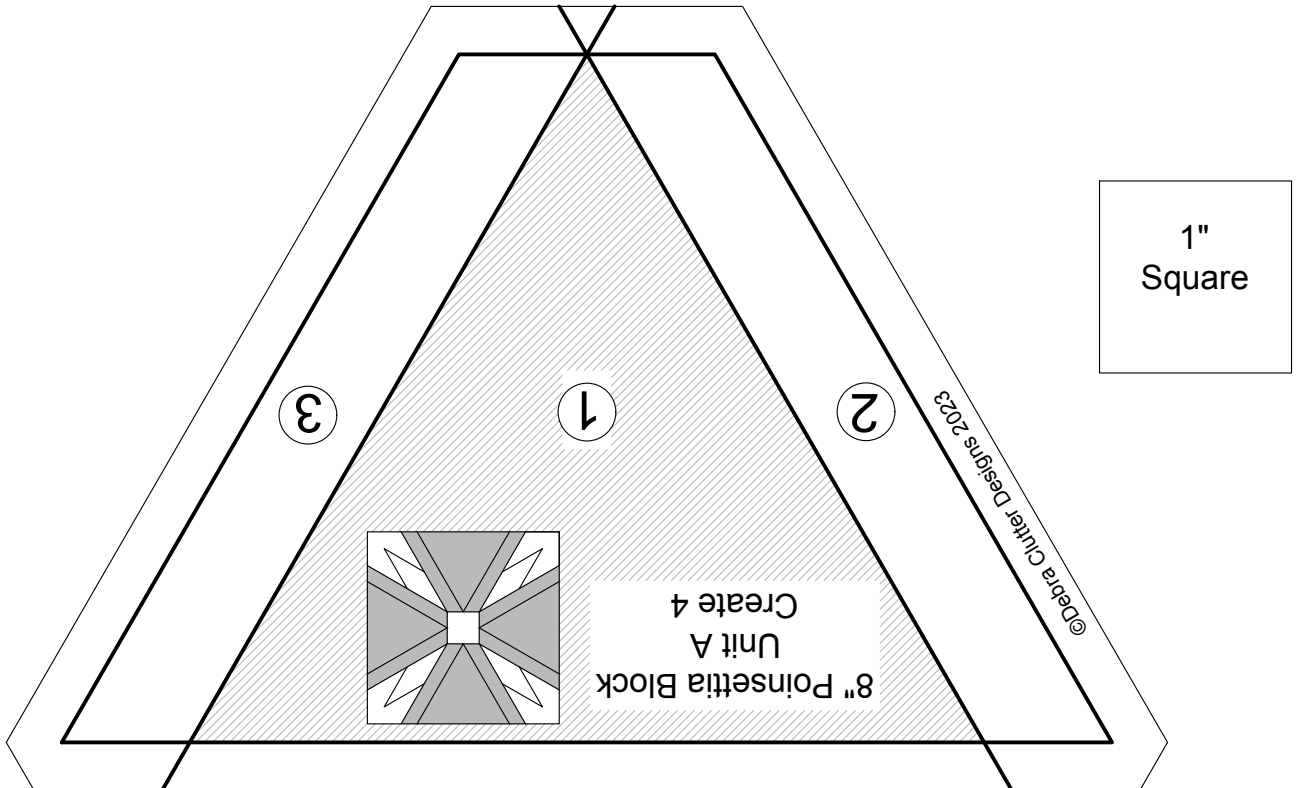
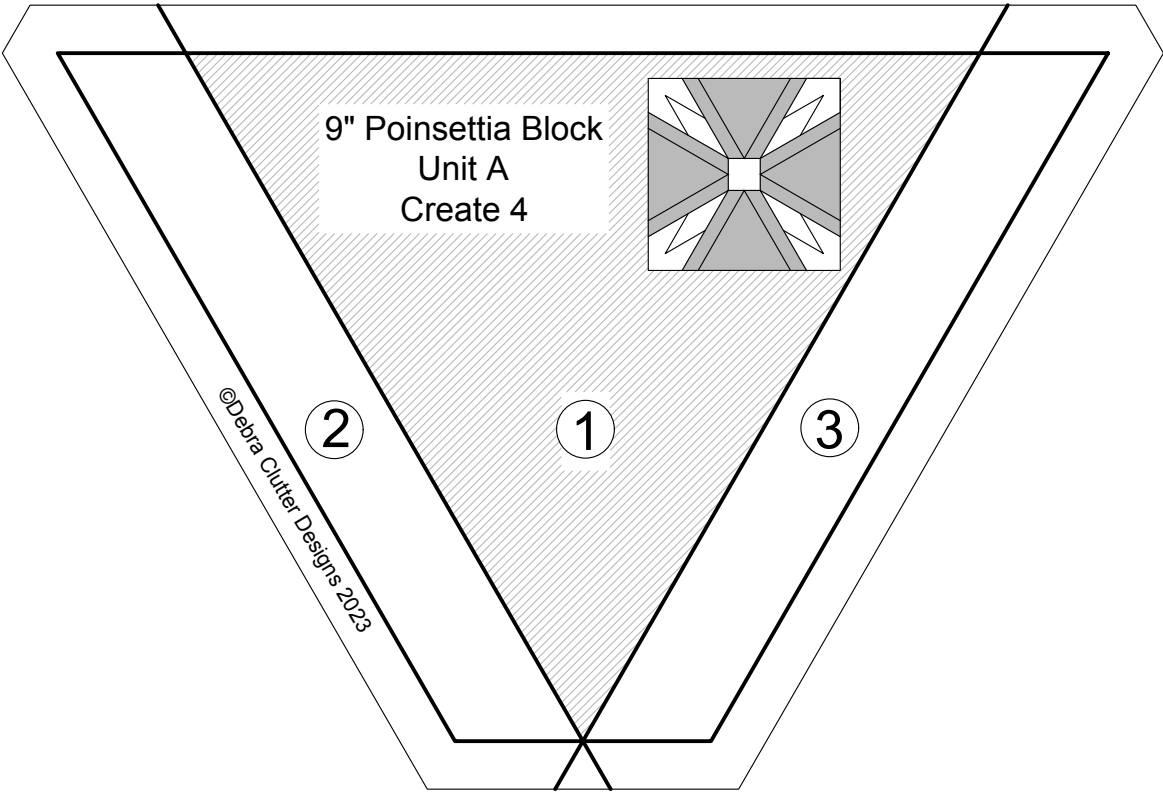



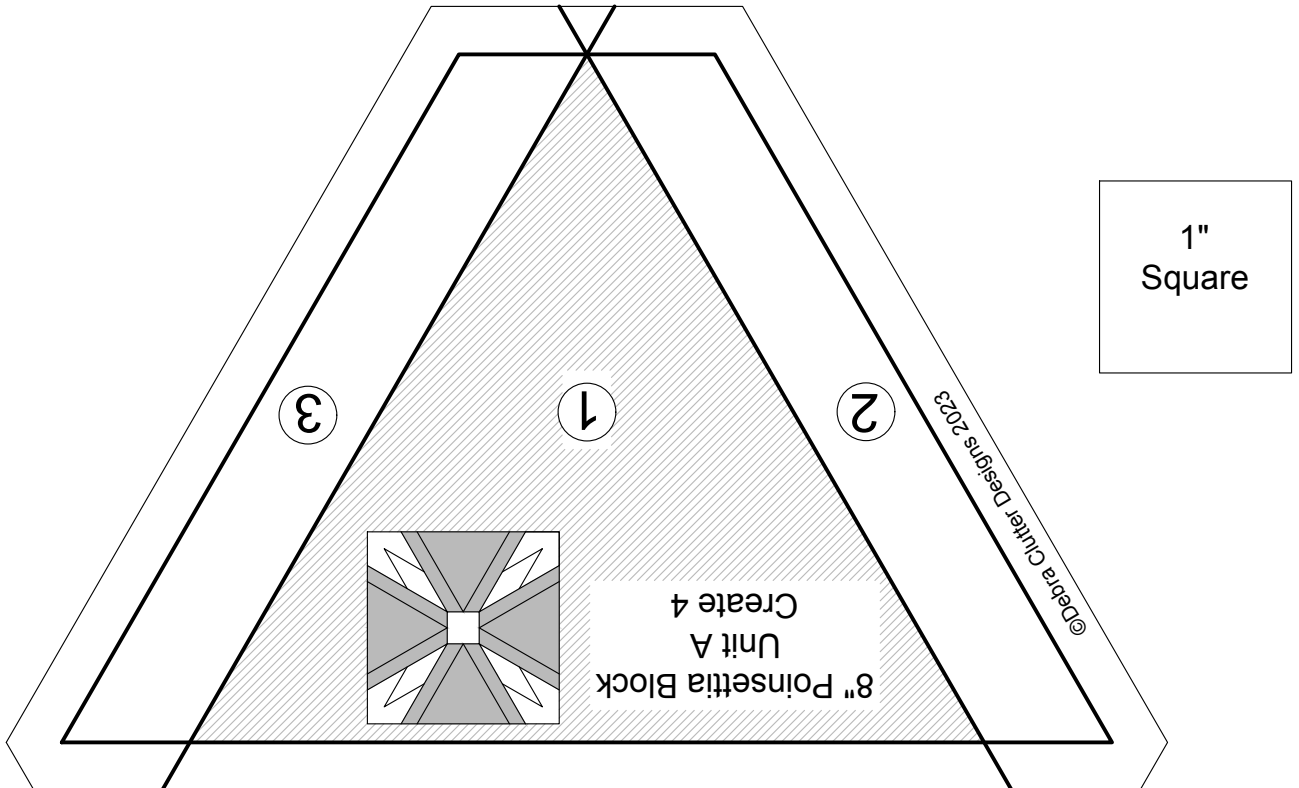
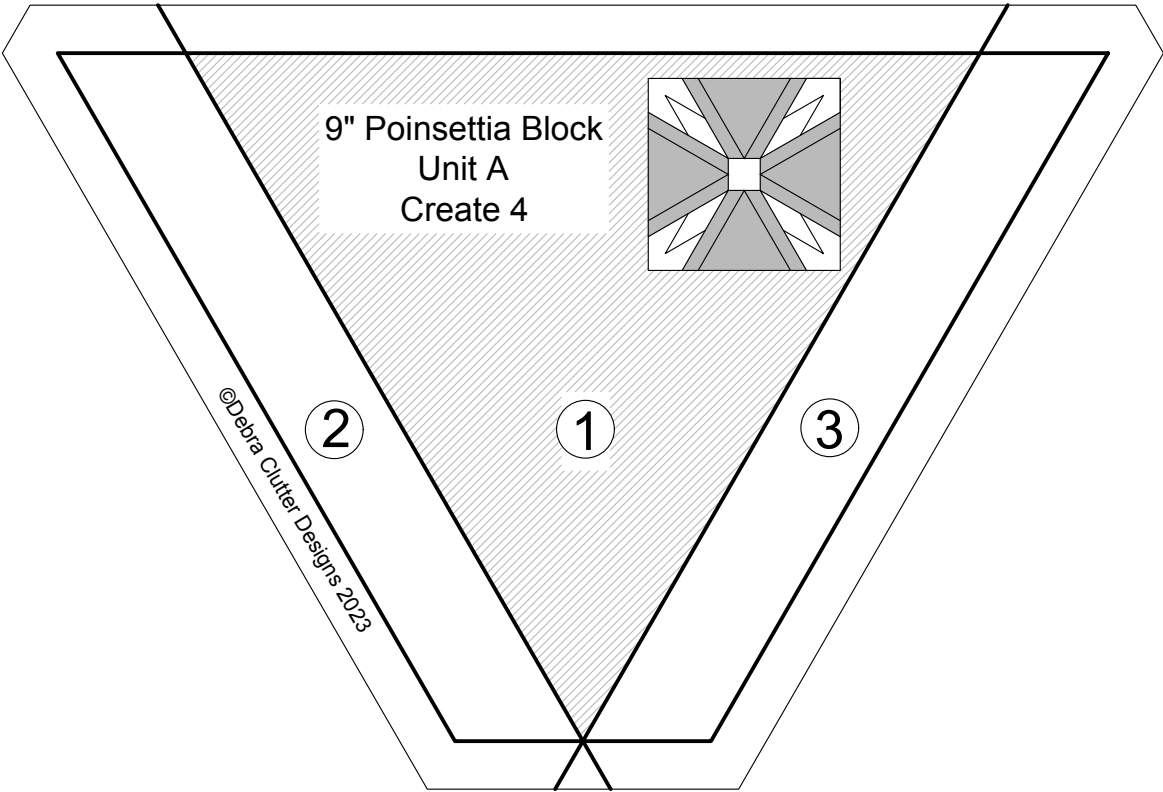

1"  
Square

