

Snowflake Star Block

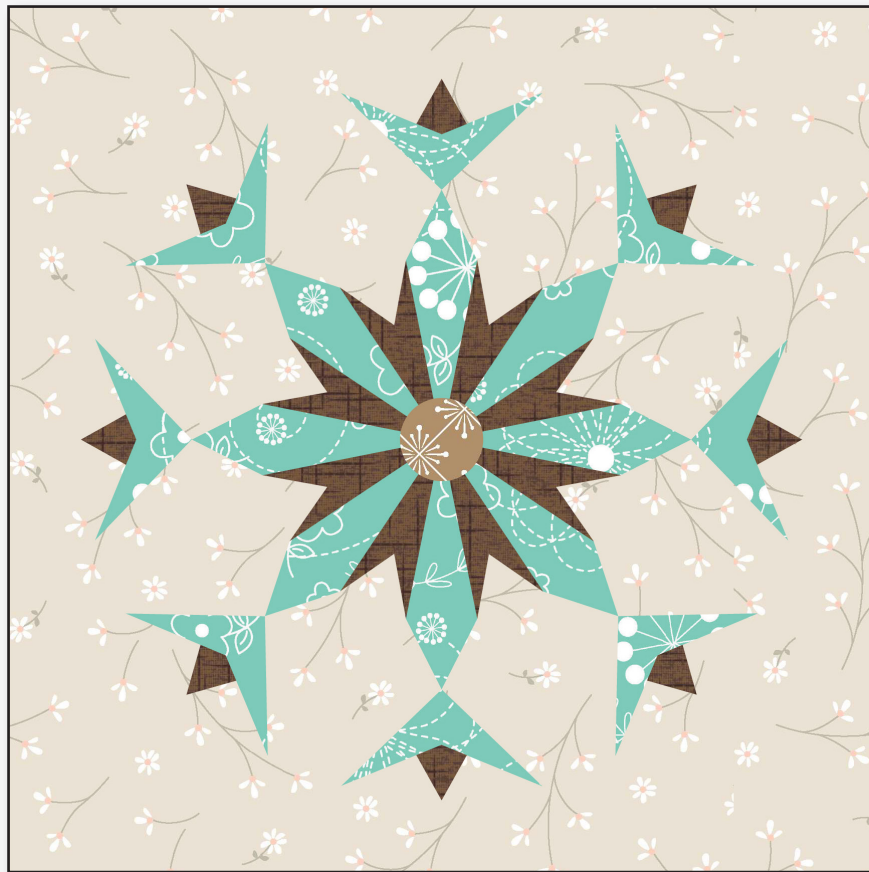

24" FPP Block



Snowflake Star Block

Supplies:

- Add-A-Quarter ruler
- Printer paper
- Washable glue stick
- 1 Yard of background fabric
- Scrap of green fabric
- 1 Fat quarter light red
- 1 Fat quarter dark red

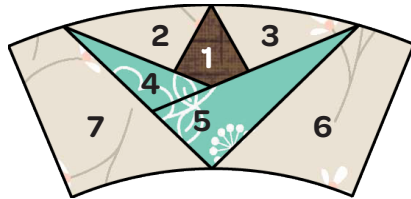

Crown - Create 8

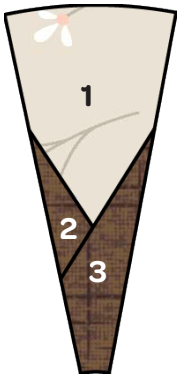

Unit A- Create 8

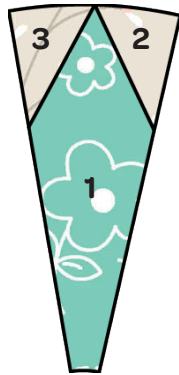

Unit B- Create 8

Unit A - Wedge

Sec	Qty	Size	Fabric Color
1	16	4" x 4 1/2"	Background
2	8	2" x 4 1/2"	Brown
3	8	2 1/2" x 6"	Brown

Unit B - Wedge

Sec	Qty	Size	Fabric Color
1	8	3" x 7"	Turquoise
2,3	*8	4" sq	Background

*Cut on the diagonal to create 2 triangles for a total of 16 pieces.

Crown

Sec	Qty	Size	Fabric Color
1	8	2 1/2" sq	Brown
2,3	16	3" x 3 1/2"	Background
4	8	1 3/4" x 4 1/2"	Turquoise
5	8	2 1/4" x 5 1/2"	Turquoise
6,7	16	3 1/4" x 6"	Background

(1) 3" sq for center circle - green

(4) from template for outside border - background fabric

Paper Pieced Instructions

1. Print 8 copies each of the foundation patterns.
2. Trim foundation papers 1/4" around the pattern.
3. Decide on your fabric colors and label each section on the pattern according to your fabric choice.
4. Cut fabric according to cutting chart and layout your fabric on your table space in the order you will sew the fabric to the foundation papers.
5. Sew the foundation papers starting with section 1. Use the glue stick to glue the wrong side of the fabric to the paper on the back side covering the seam allowance around section 1.
6. Fold back the paper using a piece of cardboard or thin plastic along the line between section 1 and 2.
7. Trim the fabric by laying the Add-A-Quarter ruler along the folded paper and trimming.
8. Lay your section 2 fabric under the section 1 fabric with right sides together along the seam allowance you trimmed in the previous step.
9. Fold the paper flat and sew on the bold line between section 1 and 2.
10. Iron the sewn section open.
11. Continue with the remaining sections by repeating step 7 through 10.
12. After the paper pattern is complete, iron flat and trim on the outside line. **Remove paper.**

Snowflake Star Block

Assembly

1. Layout star wedge units according to chart.



2. With the paper still on your units, sew units A & B together 8 times.

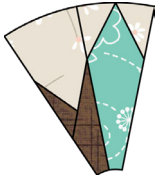

3. Sew all units together to form a circle.
4. Remove paper and applique the center circle to the center of the block.



5. Layout crown units according to the diagram.

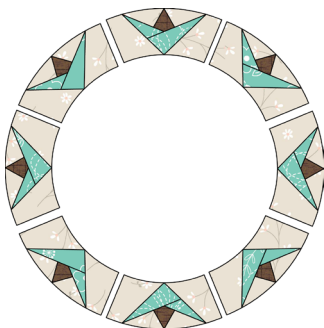

6. Sew all the crown units together to form a circle.
7. Remove the paper.

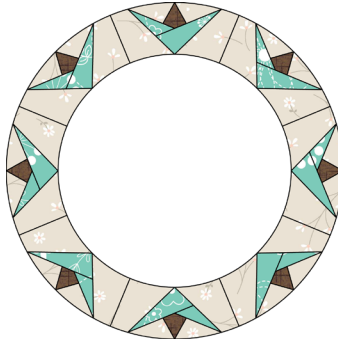

8. Sew the crown to the wedge circle unit matching the bottom points of the crown to the points of the star in the wedge circle. Press.

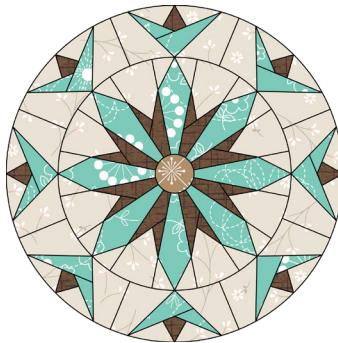

9. Print the templates for the background.
10. Trim and tape the two template pieces together.
11. Cut a piece of freezer paper 13" square or bigger. Fold it in half on the diagonal.
12. Place your paper pattern on the freezer paper with diagonal edge on fold. Trace with a pen.

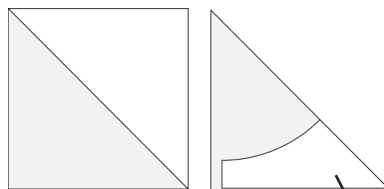

Template

13. Cut out template.
14. Iron on the freezer paper template to the background fabric
15. Cut 4 pieces out of your background fabric.
16. Sew the short edges of the background pieces together to form a square with a cut out circle in the middle.
17. Sew the background to the inside circle unit matching the top points of the crown to the four seams of the background unit. Press.

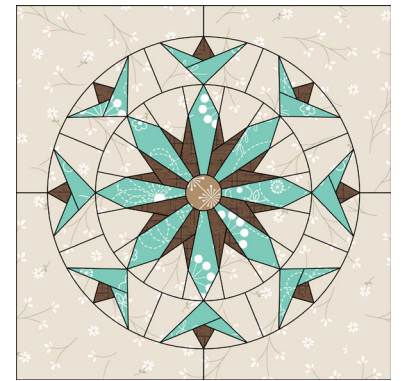
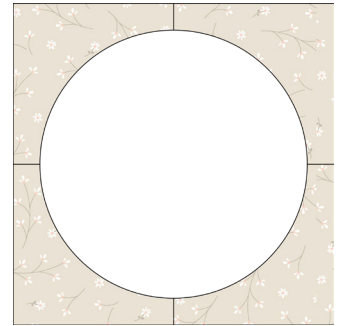

Snowflake Star Block

Here are some variations of the same block. It will look different based on the fabric you choose and where you place your lights and darks.

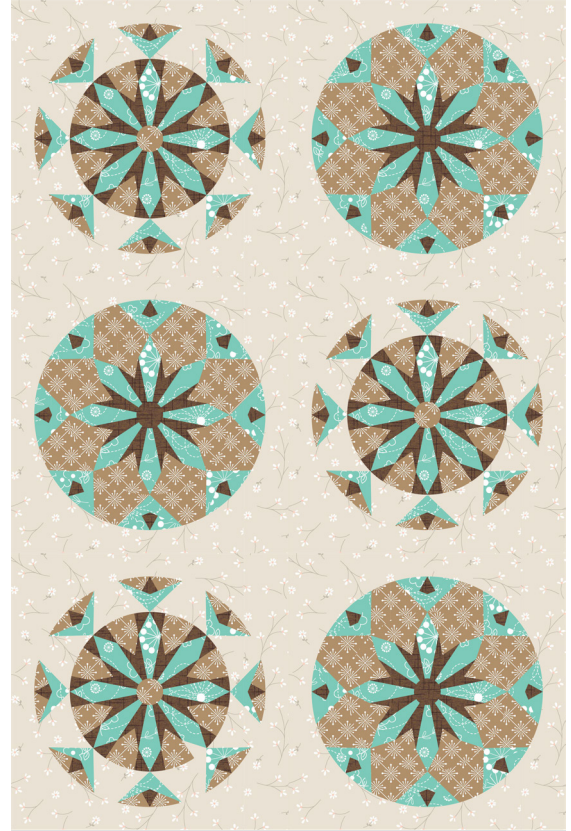

Color Your Own

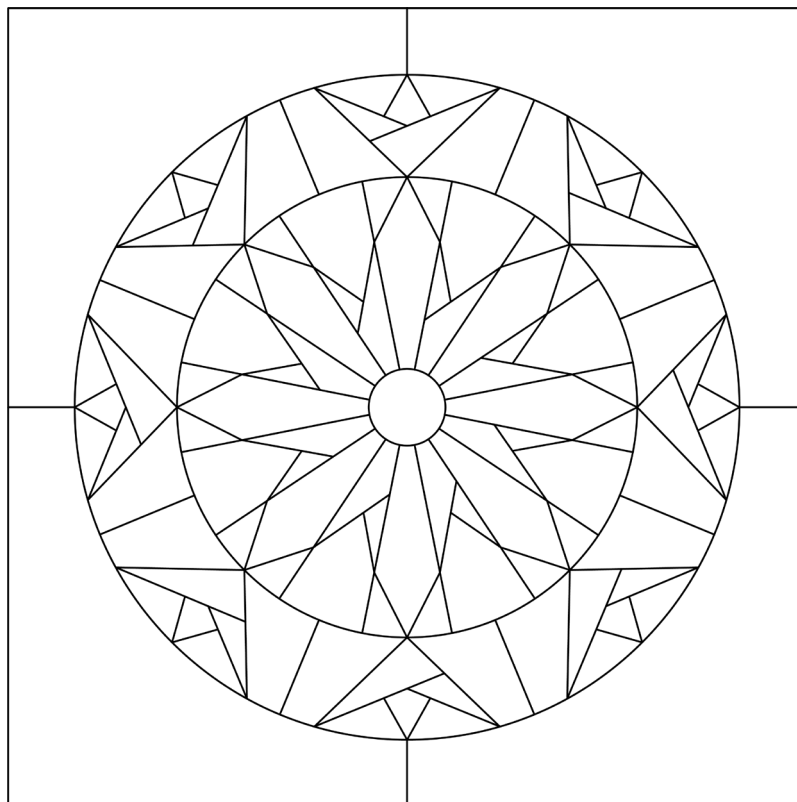

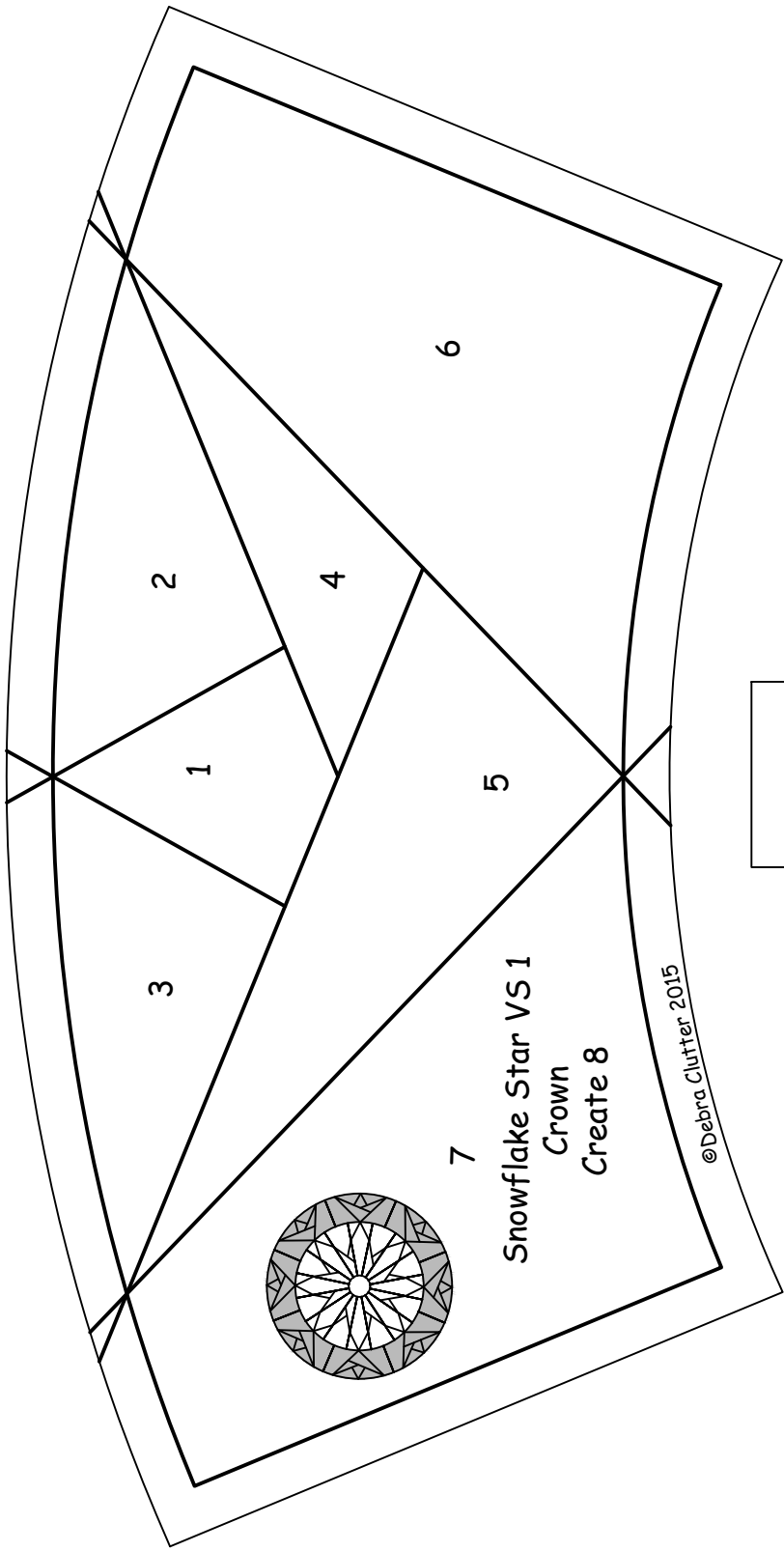

Snowflake Star VS 1
Crown
Create 8

©Debra Clutter 2015

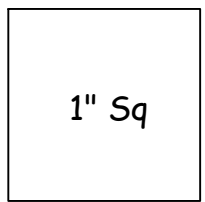

1" Sq

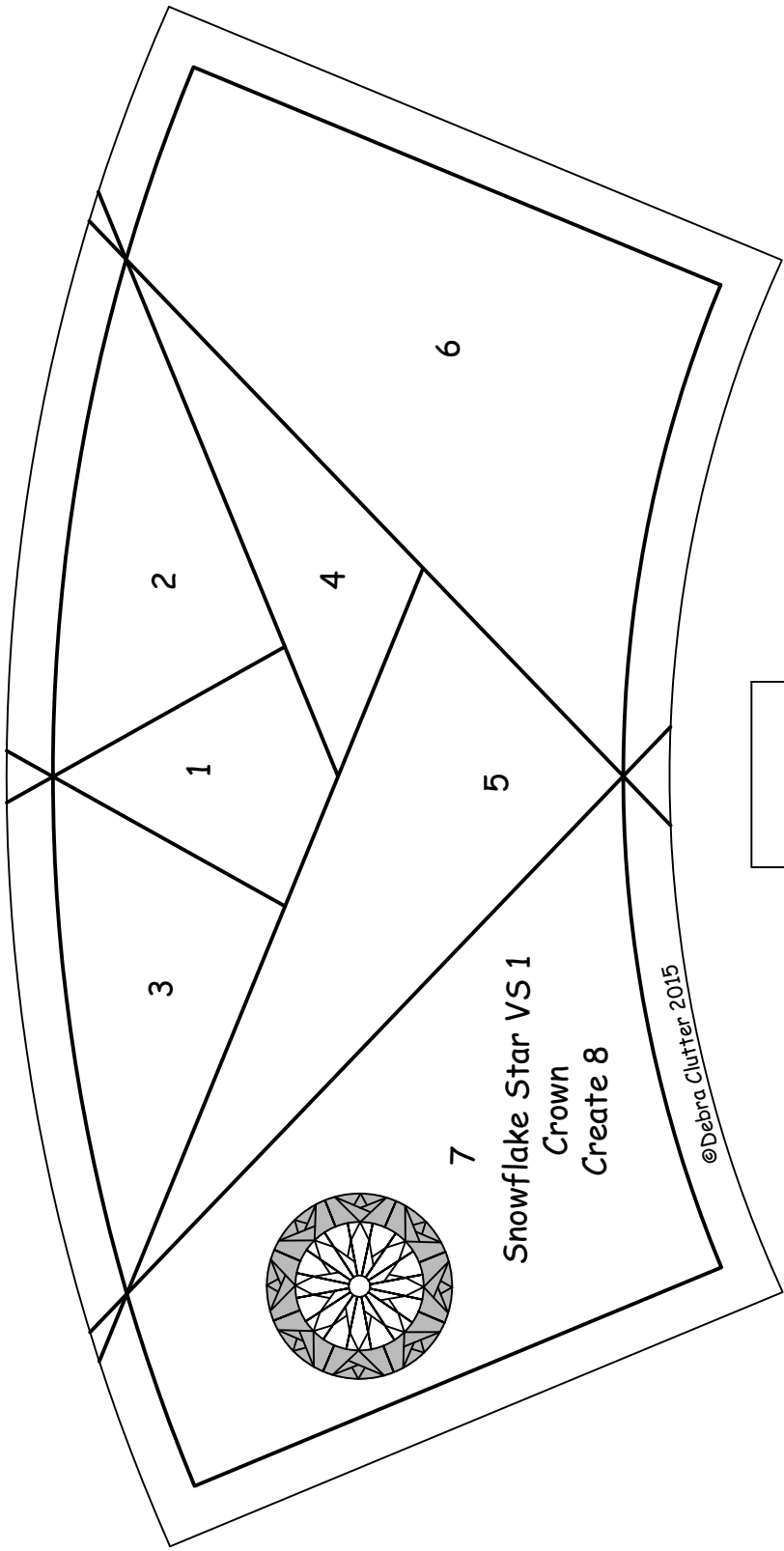

7
Snowflake Star VS 1
Crown
Create 8

©Debra Clutter 2015

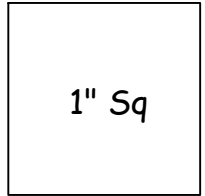

1" Sq

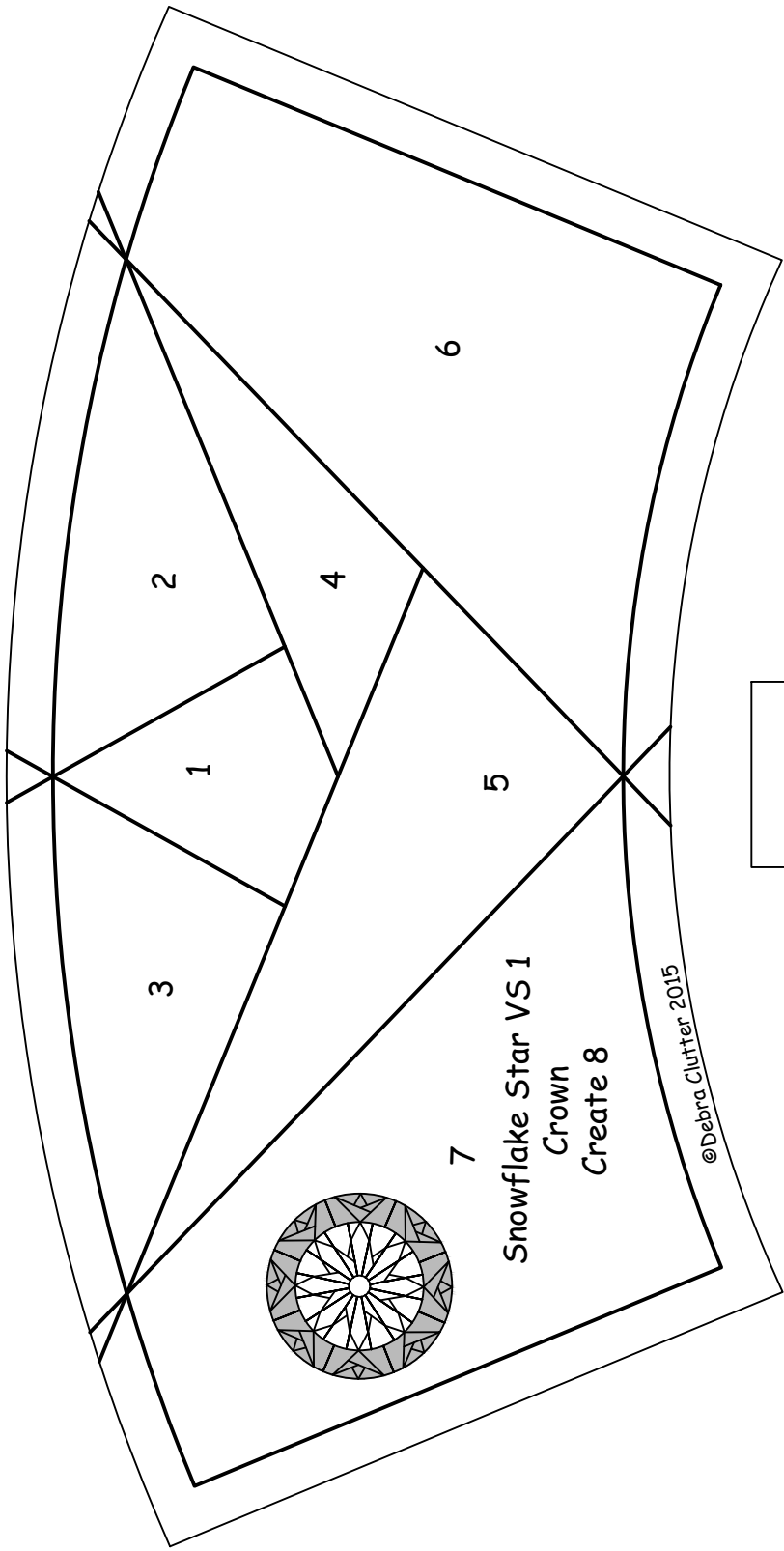

7
Snowflake Star VS 1
Crown
Create 8

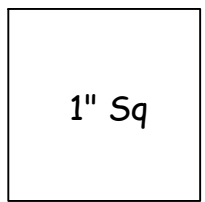

1" Sq

©Debra Clutter 2015

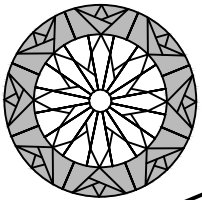
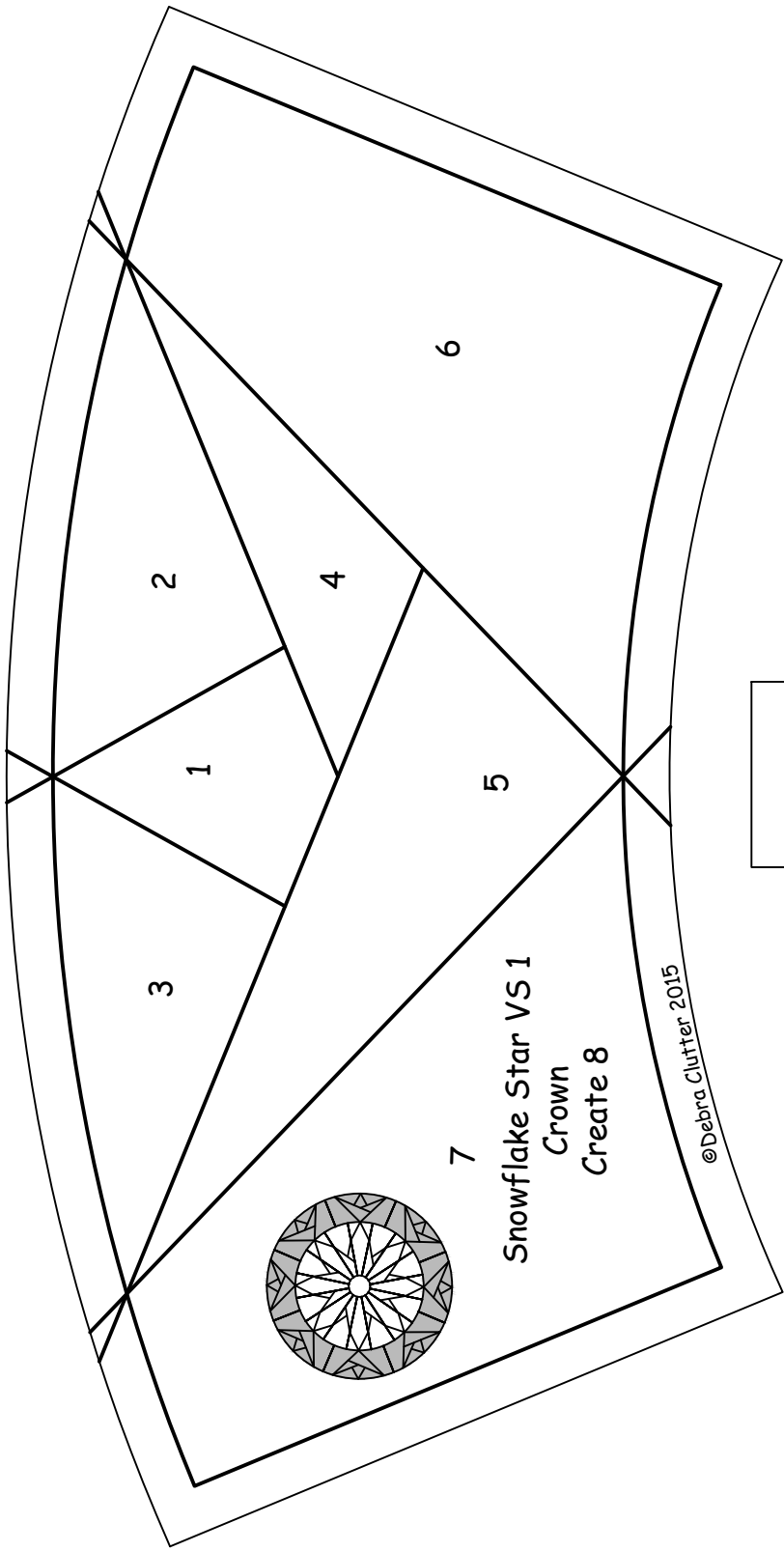

7

Snowflake Star VS 1
Crown
Create 8

©Debra Clutter 2015

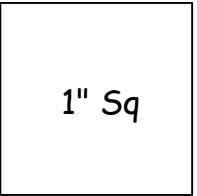

1" Sq

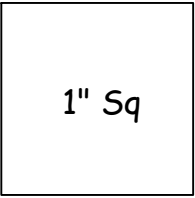
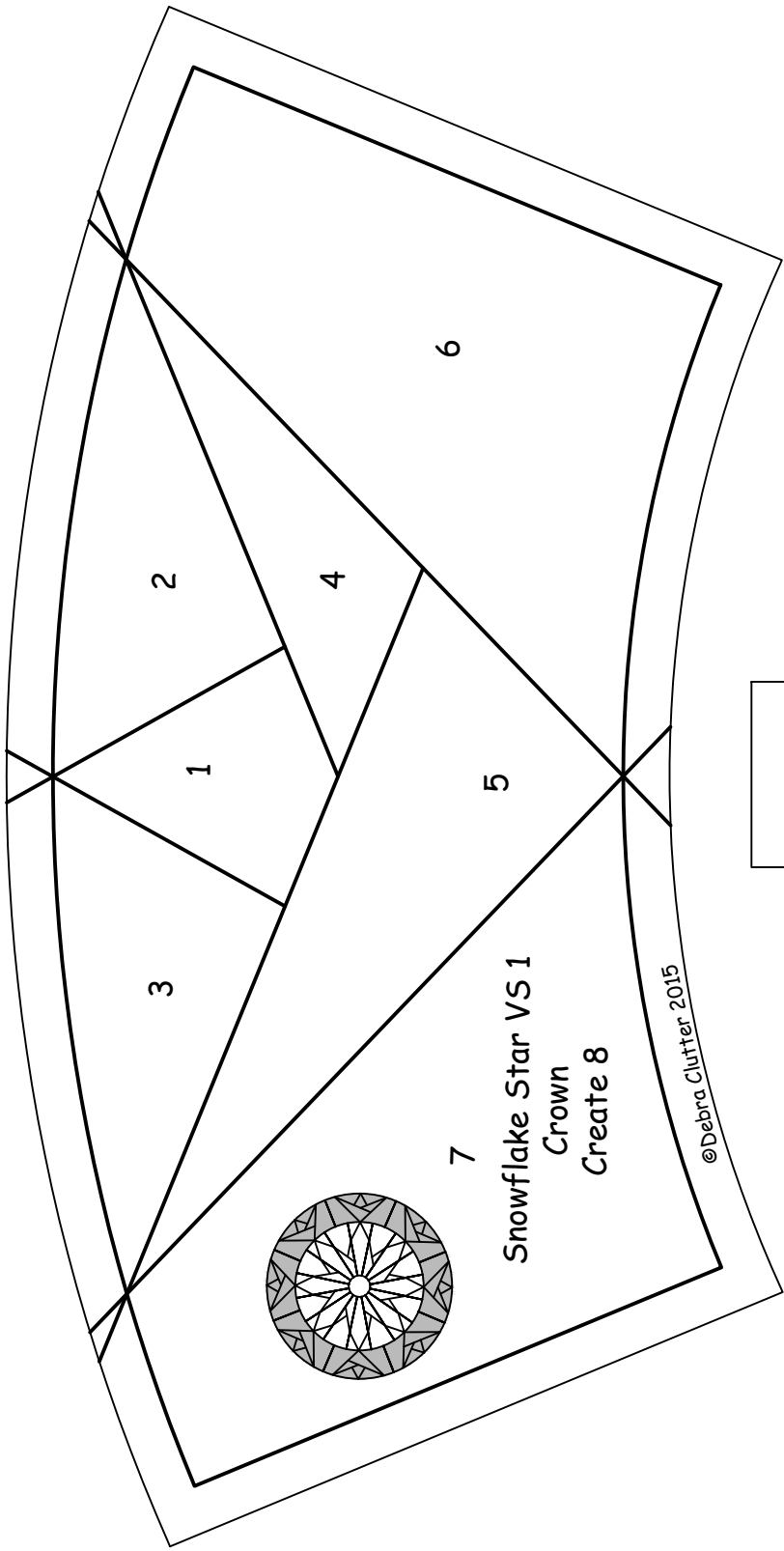

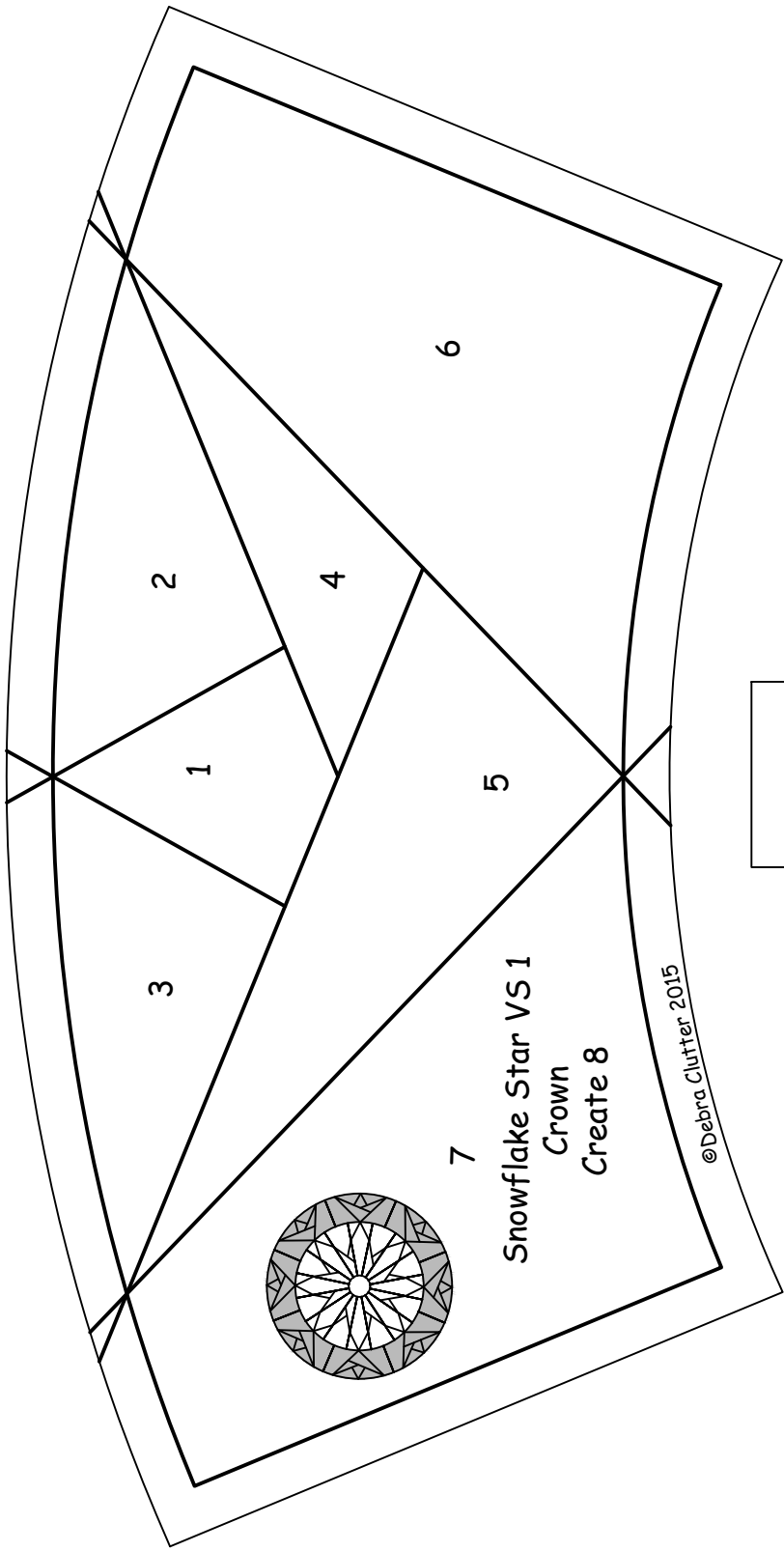

7
Snowflake Star VS 1
Crown
Create 8

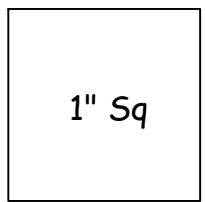

1" Sq

©Debra Clutter 2015

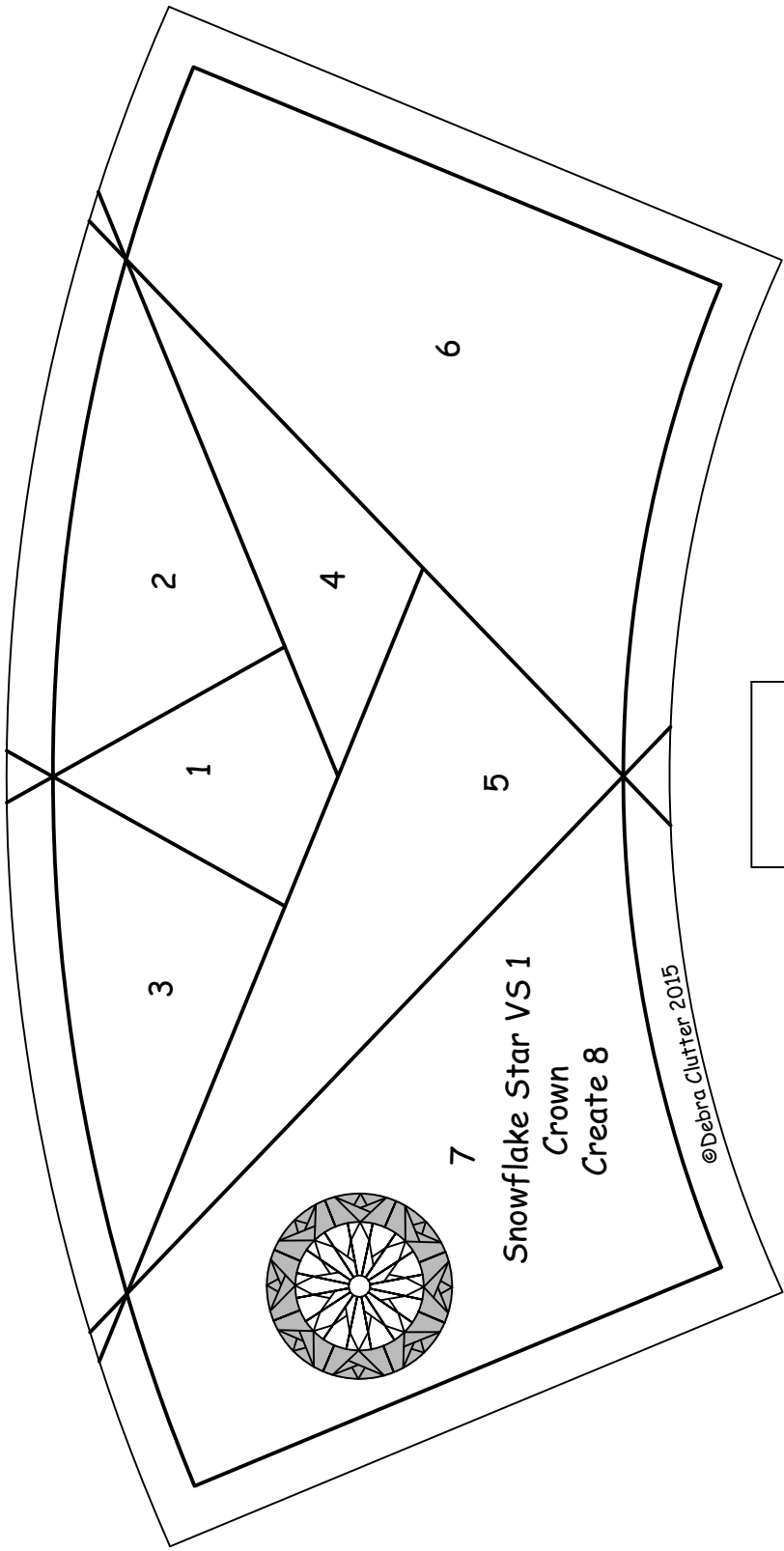

Snowflake Star VS 1
Crown
Create 8

@Debra Clutter 2015

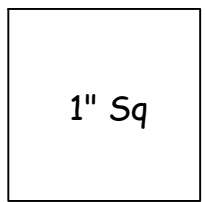

1" Sq

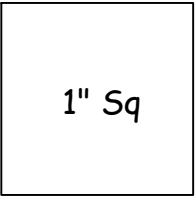
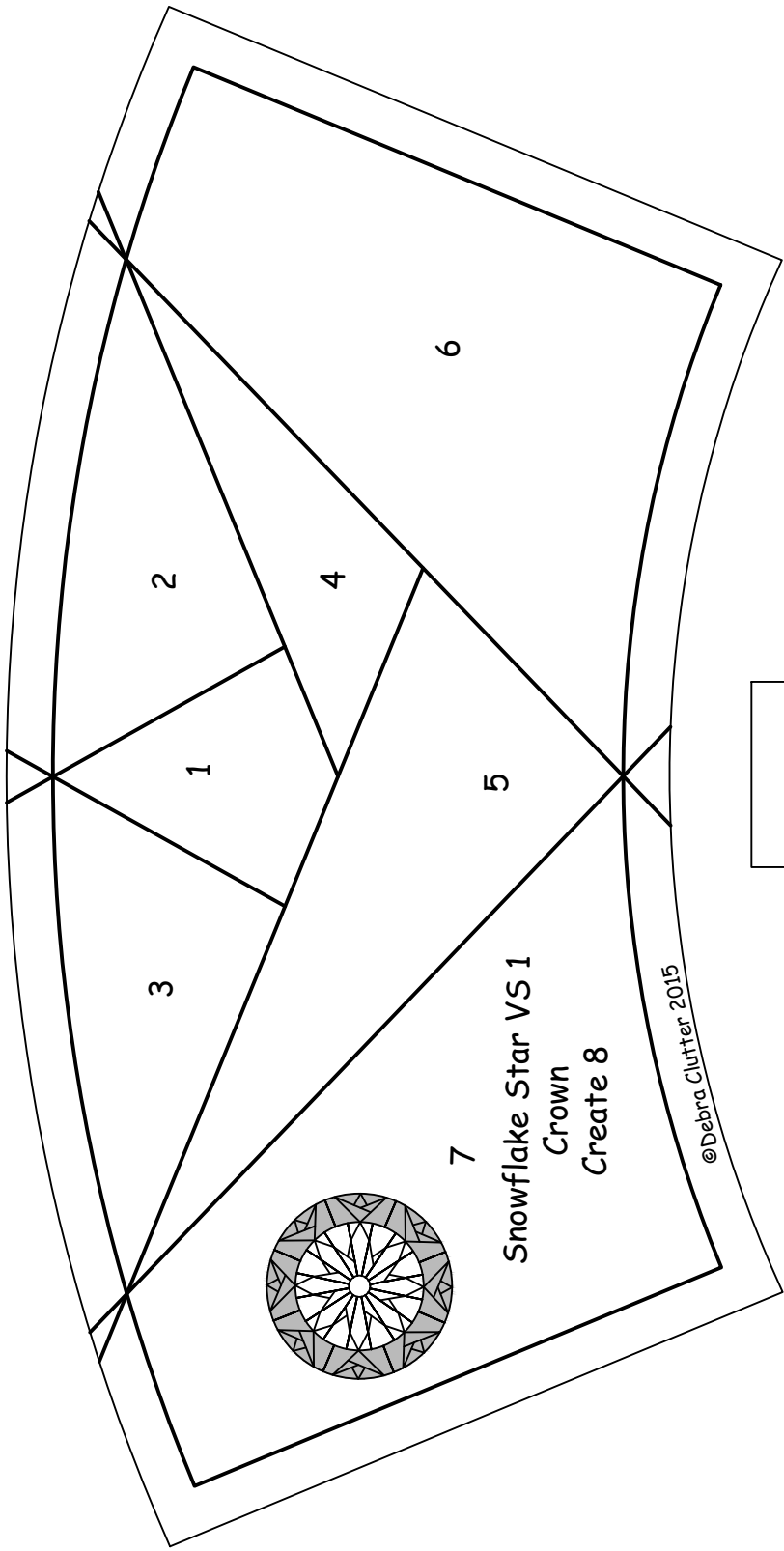

@Debra Clutter 2015

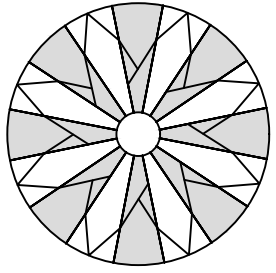

Snowflake Star VS 1
Unit A
Create 8

1

2

3

@Debra Clutter 2015

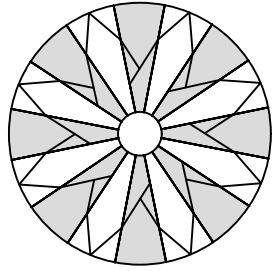

Snowflake Star VS 1
Unit A
Create 8

1

2

3

@Debra Clutter 2015

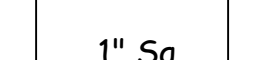

Snowflake Star VS 1
Unit A
Create 8

1

2

3

1" Sq

@Debra Clutter 2015

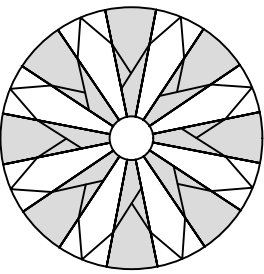

Snowflake Star VS 1
Unit A
Create 8

1

2

3

@Debra Clutter 2015

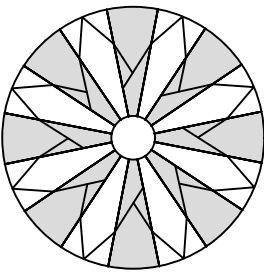

Snowflake Star VS 1
Unit A
Create 8

1

2

3

@Debra Clutter 2015

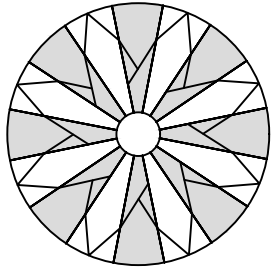

Snowflake Star VS 1
Unit A
Create 8

1

2

3

@Debra Clutter 2015

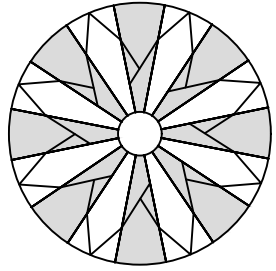

Snowflake Star VS 1
Unit A
Create 8

1

2

3

@Debra Clutter 2015

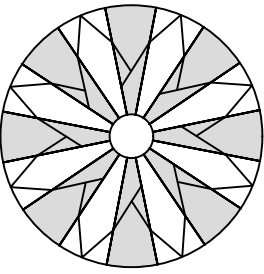

Snowflake Star VS 1
Unit A
Create 8

1

2

3

@Debra Clutter 2015

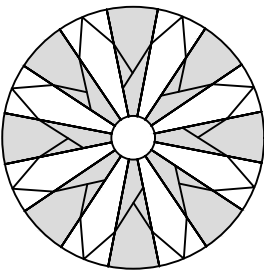

Snowflake Star VS 1
Unit A
Create 8

1

2

3

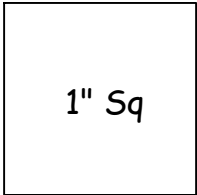

1" Sq

1" Sq

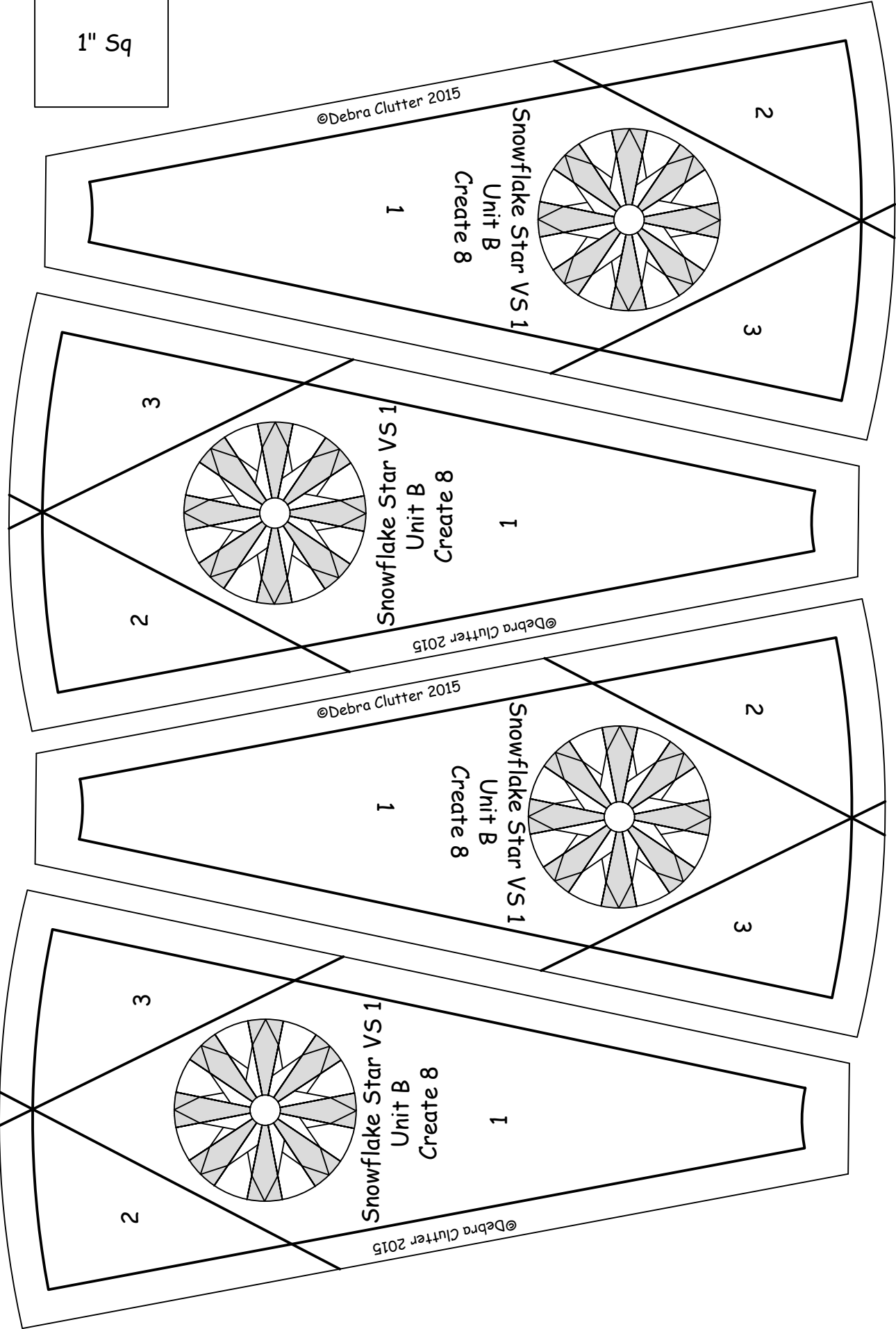

1" Sq

